



HAILO **EINBAU**TECHNIK

ABFALLTRENN- UND ORDNUNGSSYSTEME FÜR DIE KÜCHE

ORGANIZER- AND WASTE-SEPARATION-SYSTEMS FOR THE KITCHEN



Passion

Leidenschaft
Faszination

Fascination



Hailo — Die Marke steht für Qualität.

Eine Küche muss perfekt ausgestattet sein, wenn man Freude beim Kochen oder bei den anderen Arbeiten in der Küche haben will. Die Abfallentsorgung steht dabei zwar nicht im Vordergrund, spielt aber dennoch eine große Rolle bei der Nutzung aller Möglichkeiten einer modernen Küche. Auch nach vielen Jahren sollen die Produkte noch einwandfrei die Arbeit unterstützen und erleichtern. Bei Hailo wird jedes neu entwickelte Produkt erst einmal einem Dauertest unterzogen, denn unter "Made in Germany" verstehen wir wirklich das, was unsere Kunden mit dem Marktführer der Kücheneinbautechnik verbinden: Erstklassige Qualität und innovative Lösungen, die das Arbeiten in der Küche leichter und schöner machen. Das dürfen Sie von uns erwarten und daran dürfen Sie uns messen, denn diesen Anspruch wollen wir jederzeit uneingeschränkt erfüllen!

Hailo — The Brand that stands for Quality.

A kitchen needs to be perfectly equipped if you want to enjoy cooking or any of the other work that goes on in a kitchen. Waste disposal may not be the first thing that comes to mind in that regard, but it has a significant role to play when it comes to exploiting all the possibilities of the modern kitchen. The products should still work perfectly and make life easier, even after many years. At Hailo, every new product we develop first undergoes an endurance test. That's because we understand "Made in Germany" to mean precisely what our customers expect of the market leader in fitted kitchen technology: first-class quality and innovative solutions that make working in the kitchen easier and more enjoyable. That's what you can expect from us and what you should measure us by, because we want to fully meet this standard at all times!

Hailo – Eine starke Marke punktet mit Kompetenz

Hailo – A strong brand with the mark of expertise



Der rote Punkt ist unser Markenzeichen.

Er steht für Qualitäts-Produkte, die das Leben und Arbeiten im Haushalt angenehmer machen, aber auch für technische Lösungen in Bereichen wie Kücheneinbautechnik, professionelle Steigtechnik und gewerbliche Abfalltechnik. Hailo hat es durch langjähriges Know-how und die permanente Sorge um die Bedürfnisse seiner Kunden geschafft, eine Marke zu werden, der sowohl die Hausfrau als auch der professionelle Entscheider vertrauen. Unser ständiger Antrieb ist die Entwicklung von innovativen und nutzbringenden Produktlösungen.

The red dot is our trademark.

It stands for quality products that make life and housework better, but also for technical solutions required for fitted kitchen design, professional ladder systems and commercial waste systems. With the expertise it has accumulated over many years of expertise and its ongoing attention to the needs of its customers, Hailo has become a brand you can trust – when doing jobs at home or as a professional investment. We are constantly driven to develop innovative and beneficial product solutions.

Die dynamischen Veränderungen im Markt und unser Know-how in der Kücheneinbautechnik haben uns zu einem zuverlässigen Partner bei den führenden Küchenherstellern gemacht.

Hailo bietet innovative Lösungskonzepte.

The dynamic changes in the market and our know-how in kitchen built-in technology made us a reliable partner for the leading kitchen manufacturers.

Hailo provides innovative concept solutions.



Hailo Professional
Steigtechnik und Leiternsysteme für Gebäude und Zugänge aller Art.

Hailo Professional
Ladder systems for buildings and access of any kind.



Hailo Home & Business
Steigergeräte für Haus und Garten, Abfallsammler für Küche und Bad.

Hailo Home & Business
Ladders for home and garden, waste bins for the kitchen and bathroom.



Hailo Einbautechnik
Abfalltrenn- und Ordnungssysteme für die Küchenmöbelindustrie.

Hailo Built-In Technology
Waste separation and storage systems for the kitchen industry.



Hailo – Ein starkes Team
Hailo – a strong team

Ob kundenspezifische Einbaulösungen, standardisierte Produkte, Beratung für praktische Produktkombinationen – ein kompetentes und motiviertes Team mit großem Knowhow und langjähriger Erfahrung steht Ihnen in allen Belangen gerne zur Verfügung!

Whether you're looking for customer-specific fitted solutions, standardised products or advice on useful product combinations, our professional and dedicated team is at your service to offer their great expertise and long-standing experience and will be delighted to assist you with all your needs.

Hailo – Messen
Hailo – Fairs



Hailo Einbautechnik ist auf den für unsere Kunden relevanten Messen präsent. Hier zeigen wir einen repräsentativen Auszug aus unserem umfangreichen Produktportfolio. Hier stehen wir mit kompetentem Personal für Fachgespräche bereit. Hier werden zusammen mit Ihnen, bei Bedarf, Neuheiten besprochen und entwickelt. Wir laden Sie herzlich ein, uns auf folgenden Messen zu kontaktieren: Interzum / SICAM / ZOW

Hailo Built-In Technology attends trade fairs that are relevant to our customers. This is where we exhibit a representative selection of our comprehensive product portfolio. It is where our professional staff are waiting to discuss your specific needs. And it is where – together with you – new products and services are discussed and developed as required. We cordially invite you to contact us at the following trade fairs: Interzum / SICAM / ZOW



Hailo – Ausgezeichnetes Design

Hailo – Awarded designs

Unsere Einbau-Produkte bieten mehr als Funktionalität und Qualität: Für ihr außergewöhnliches Design erhielten sie bereits viele Auszeichnungen wie den red dot award, den iF Design Award und den Interzum Award.

Our built-in products offer more than just functionality and quality. They have already received a number of awards for their exceptional design, such as the red dot award, the iF Design Award and the Interzum Design Award.

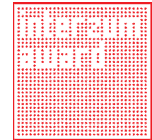

Hailo – Eine starke Marke punktet mit Montagefreundlichkeit und Service

Hailo - A strong brand with the benefits of easy installation and great service



Übersichtliche Montageanleitungen

Jedem Hailo-Einbau-Produkt liegt eine übersichtliche, bebilderte Montageanleitung bei.

Clear and illustrated Installation Instructions

All Hailo built-in products are supplied with a clear installation instruction.



Montage-Videos

In verschiedenen Montagevideos werden alle nötigen Arbeitsschritte anschaulich dargestellt. Diese Videos finden Sie in der Mediendatenbank der Hailo Einbautechnik Website oder im YouTube Channel von Hailo Einbautechnik.

Installation videos

All the essential steps are clearly presented in different installation videos. You can download the video on the Hailo Built-In Technology website or simply view it at the YouTube channel of Hailo Built-In Technology.



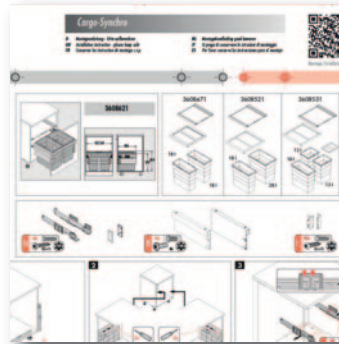

Montageanleitungen als PDF-Download
Auf der Hailo-Webseite stehen alle Montageanleitungen und Maßskizzen als PDF-Download zur Verfügung.

Installation instructions and dimensional diagrams are available as PDFs for downloading
All installation instructions and dimensional diagrams are available on the Hailo website for downloading as PDF files.



Hailo – Eine starke Marke punktet am POS
Hailo - A strong brand with PoS benefits

Plakate, Displays, Aufkleber etc. für den POS in Küchenstudio und Möbelhandel stellen wir gerne zur Verfügung.
We would be delighted to supply you with posters, displays, stickers, etc., for PoS use in kitchen showrooms and furniture stores.



Hailo - Digitale Helfer

Hailo - Digital Assistants

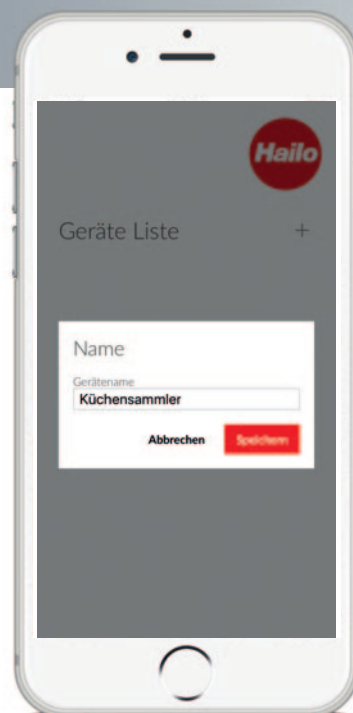
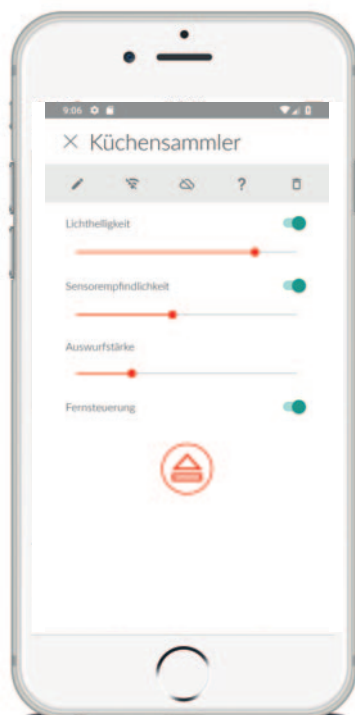

Hailo App "Hailo Connect"



ANDROID



IOS

Mit Hilfe einer App können per Smartphone verschiedene Funktionen der elektronischen Öffnungsunterstützung Libero 2.0 und Libero 3.0 eingestellt werden.

Die App ist für Android und iOS erhältlich und steht kostenlos zum Download zur Verfügung. Konfigurations- und Einstellungsmöglichkeiten:

- LED Leuchte aus/ ein
- Regelung der Auswurfstärke
- Regelung der Sensor-Empfindlichkeit

Weitere nützliche Funktionen werden die Hailo App zukünftig ergänzen.

By means of an App various features of the "Libero 2.0 and Libero 3.0" electronic opener may be set by SmartPhone.

This App is available for free download, for Android and iOS phones.

Configurations and Adjustments:

- LED indicator Light off / on
- Adjustment of push-out Force
- Setting of Sensor-Sensitivity

Additional useful features will complete the Hailo App in future.

Hailo – 100.000 mal getestet
 Hailo - 100,000 times tested



Alle Hailo Systeme unterliegen strengsten Qualitätsprüfungen. Eine neue Produktserie geht erst in den Markt, wenn z.B. 100.000 Auszugszyklen unter strengen Laborbedingungen getestet wurden. Hochwertige Auszugschienen gewährleisten sicheren, ruhigen Lauf – ein Produktleben lang! Man sieht sie nicht, aber man fühlt und spürt sie bei jeder Betätigung. Hailo Einbautechnik erfüllt in allen Belangen die hohen Anforderungen anspruchsvoller Kunden. Dieser Qualitätsanspruch ist uns Verpflichtung. Dazu zählt auch der Einsatz hochwertiger Materialien.

All Hailo Systems are being tested according to the toughest Quality-Control-Requirements. We would not release any new series for our markets, unless they have, successfully, passed min. 100,000 pullout cycles lifetime tests, with increased trash-load and front-panels attached. High-end slides ensure a smooth, safe and silent pullout – over the entire lifetime period. You would hardly see them, but you can feel and realize them during every use. Hailo Built-In Technology fulfills or exceeds the high requirements of our demanding customers. Those quality expectations are our commitments. This, surely, also includes the use of premium materials and components.



Hailo – Eine starke Marke punktet auch Online

Hailo - A strong brand with online benefits as well

🇩🇪 Home | Händler | Ersatzteilshop | Kontakt | 🔍 suchen...



PRODUKTE EINBAUARIANTEN UNTERNEHMEN SERVICE NEWS & PRESSE



DIE NEUEN VON HAILO EINBAUTECHNIK



HAILO CARGO SYNCHRO



HAILO LAUNDRY AREA



HAILO LIBERO 2.0

Übersichtliche Vielfalt

Auf der Hailo Website bieten wir Industrie, Handel und Endkunden gleichermaßen nützliche Informationen zu unseren Produkten und Leistungen. Egal ob Sie per Suchmaske die Artikelnummer oder den Produktnamen eingeben oder ob Sie über die Textnavigation bzw. Bildnavigation etwas suchen – viele Wege führen Sie zur gewünschten Information.

Clean diversity

On the Hailo website, we provide industry, trade and end customers with useful information on our products and services in equal measure. There are many ways to access the information you require: you can enter either the item number or the product name into the search screen or search for something via the navigation bar by text or by image.

www.hailo-einbautechnik.de

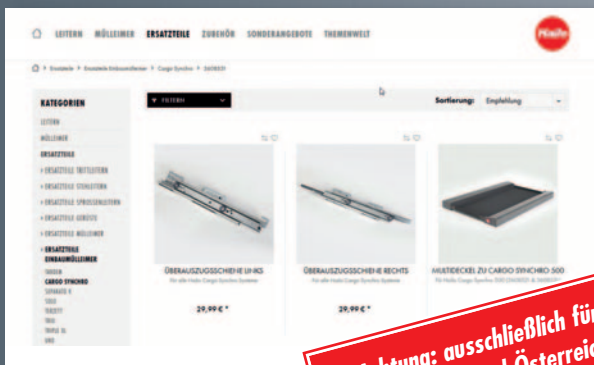
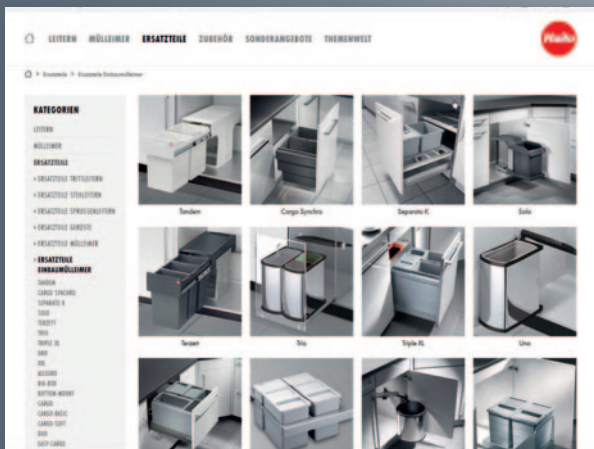

Achtung: ausschließlich für Deutschland und Österreich!
Please note: For Germany and Austria only!

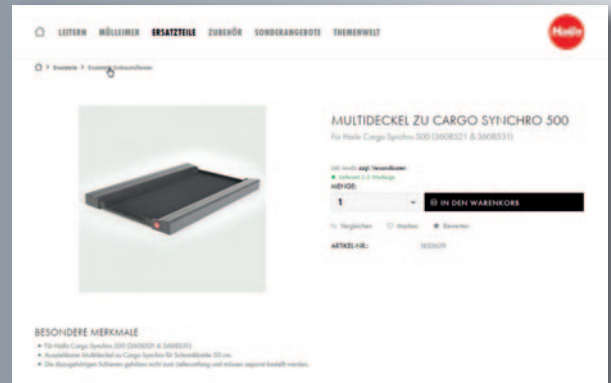

Zubehör & Ersatzteile für Endkunden

Für Handels- und Endkunden in Deutschland, und Österreich bieten wir mit unserem Online-Ersatzteilshop einen gerne genutzten Service. Hier finden Sie passendes Zubehör und Ersatzteile zu Hailo Einbautechnik Produkten. Bequem online bestellen. shop.hailo-einbautechnik.de

Accessories & Spare parts for customers

If you're a trade customer or end customer in Germany or Austria, we provide a service you'll love to use: our Online Parts Shop. Here, you'll find the right accessories and parts for Hailo Built-In Technology products. Order online at your convenience. shop.hailo-einbautechnik.de

1 Produktart Product

- AS = Abfallsammler Waste bin**
- OS = Ordnungssystem Organizer system**
- CS = Kundenspezifische Lösung Customized Solution**
- FS = Funktionssystem Functional system**

2 Serienname Name of the series

3 Schrankbreite (in mm) Cabinet width (in mm)

Angabe Schrankbreite entfällt bei Systemen, die in unterschiedlich breite Schränke passen.

The cabinet widths are not mentioned for products or series that are designed for varying unit widths.

4 Bezeichnung des Inneneimers Name of inner bins

Beispiel: 20/10/10/D
= 1 x 20L, 2 x 10L + 1x Deckel

Example: 20/10/10/D
= 1 x 20L, 2 x 10L + 1 x Lid

5 Zubehör Accessories

- D = Deckel Lid**
- KS = Kehrset Dust-pan & -brush**
- P = Putzmittelkorb Cleaners basket**
- U = Utensiliendepot Utensil bowl**
- K = Kitty Kitty**
- ME = Multifunktionseimer Multifunctional bucket**

Beispiel: 15/15/7,5/7,5/D/KS/U/U
= 2 x 15L, 2 x 7,5L + Deckel; Kehrset;
2 x Utensiliendepot

Example: 15/15/7,5/7,5/D/KS/U/U
= 2 x 15L, 2 x 7,5L + Lid;
Storage compartments; 2 x Utensil bowl

Das D (Deckel) wird immer dem Inneneimer angehängt, der mit Deckel ausgestattet ist.

The letter "D" (for Deckel = Lid) is printed right behind the inner bin that comes with that individual plastic Lid.

Beispiel: Hailo AS Euro Cargo 600 ST
38/38/12/D/2,5

Hier bezieht sich das "D" auf den Deckel des vorhergenannten Inneneimer 12

Example: Hailo AS Euro Cargo 600 ST
38/38/12/D/2.5

The letter "D" refers to the Deckel i.e. to the Lid for the earlier mentioned 12 L inner bin.

6 Farben Colour

hellgrau light grey
 dunkelgrau dark grey
 creme cream
 weiß white
 braun brown
 silber silver

7 Passende Müllbeutel Matching bin liners

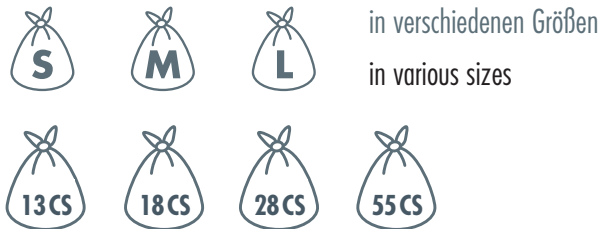

Beispiel: Example:

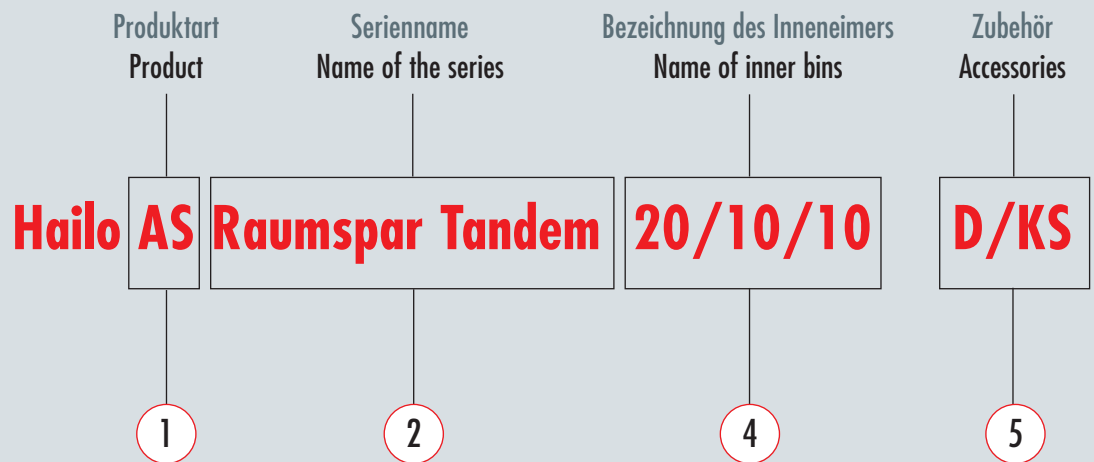

Beispiel: Example:

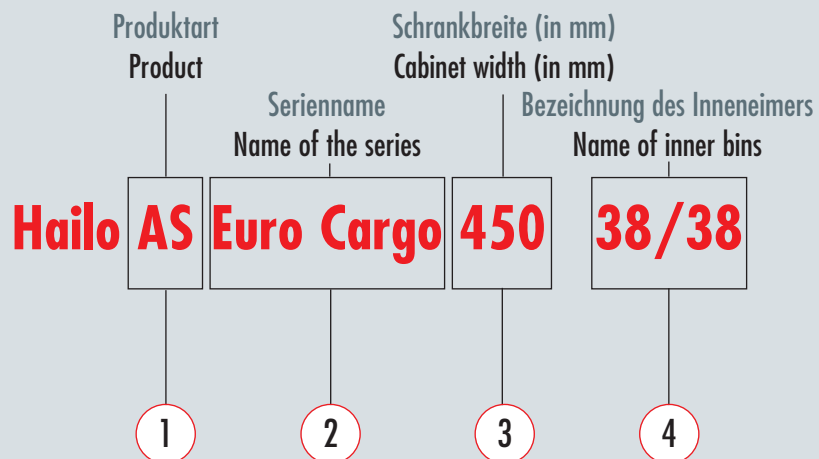

Küchen-Einbautechnik, *passgenau!*

Kitchen Built-in Technology *which always fits!*



Schrankbreiten / Cabinet width:



Swing

Einbau-Systeme für Drehtürschränke

Fitment Systems for hinged door cabinets

30 cm Breite/Width	Seite/ Page	21
40 cm Breite/Width	Seite/ Page	41
45 cm Breite/Width	Seite/ Page	65
50 cm Breite/Width	Seite/ Page	87
60 cm Breite/Width	Seite/ Page	107
Diagonal-Eckspülenschrank	Seite/ Page	139
Diagonal door corner-sink-cabinets		



Slide

Einbau-Systeme mit Frontanbindung

Fitment Systems for front-mount-door cabinets

30 cm Breite/Width	Seite/ Page	31
40 cm Breite/Width	Seite/ Page	61
45 cm Breite/Width	Seite/ Page	71
50 cm Breite/Width	Seite/ Page	91
60 cm Breite/Width	Seite/ Page	111



Inset

Einbau-Systeme zum Einsatz in Schubkästen

Fitment Systems for installation into standard-drawers

30 cm Breite/Width	Seite/ Page	37
45 cm Breite/Width	Seite/ Page	81
50 cm Breite/Width	Seite/ Page	101
60 cm Breite/Width	Seite/ Page	123
80 cm Breite/Width	Seite/ Page	129
90 cm Breite/Width	Seite/ Page	133

Abfallsammler und Abfalltrennsysteme

Waste bins and waste separation systems



Ordnungssysteme

Organizer systems

Seite 145

Page 145



Funktionssysteme

Functional systems

Seite 169

Page 169



Wäschepflege / Hauswirtschaftsraum

Laundry Care / Utility Room

Seite 187

Page 187



Eimer, Einsätze, Zubehör

Bins, Inserts, Accessories

Seite 213

Page 213



Kundenspezifische Lösungen

Customized Solutions

Seite 240

Page 240

Abfallsammler & Abfalltrennsysteme

Waste bins and waste separation systems



Abfallsammler und Abfalltrennsysteme Waste bins and waste separation systems



Schrankbreite:
Cabinet width:

30 cm

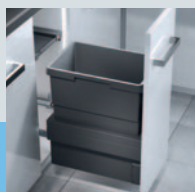

Seite / Page 21 - 39

40 cm



Seite / Page 41 - 63

45 cm



Seite / Page 65 - 85

50 cm

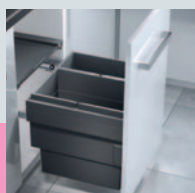

Seite / Page 87 - 105

60 cm



Seite / Page 107 - 127

80 cm



Seite / Page 129 - 131

90 cm



Seite / Page 133 - 143



Übrigens, wussten Sie, ...

dass der Hailo Tandem mit über 13 Mio. Exemplaren das meistverkaufte Einbau-Abfalltrennsystem der Welt ist?

By the way, did you know...

that the Hailo Tandem is the most sold fitted waste separation system in the world, with more than 13 million units sold?

Swing

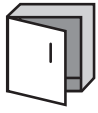

Für Schränke ab 300 mm Breite mit Drehtür
For hinged door cabinets from 300 mm width



DAS ORIGINAL



30 cm

Swing



Für Schränke ab 300 mm Breite mit Drehtür For hinged door cabinets from 300 mm width

Tandem



Hailo AS Tandem 15/15/D hellgrau

3666821



- Trennung: 2-fach
- Abfalleimer: 2 x 15 l, Gesamtvolumen 30 l, 1 x Behälterdeckel 15 l
- **Montageart: Bodenmontage**
- Auszugsschienen: Vollauszug
- Farbe: Metallteile silberfarben, Kunststoffteile hellgrau
- Produkt-Maße: B x T x H, 251 x 482 x 400 mm
- Verpackungsmaße: B x T x H, 260 x 504 x 420 mm
- Gewicht mit Verpackung: 7,8 kg



Tandem



Hailo AS Tandem 24/7 dunkelgrau

3666111



- Trennung: 2-fach
- Abfalleimer: 1 x 24 l, 1 x 7 l, Gesamtvolumen 31 l
- **Montageart: Bodenmontage**
- Auszugsschienen: Vollauszug
- Farbe: Metallteile silberfarben, Kunststoffteile dunkelgrau
- Produkt-Maße: B x T x H, 251 x 482 x 400 mm
- Verpackungsmaße: B x T x H, 260 x 504 x 420 mm
- Gewicht mit Verpackung: 7,05 kg



Tandem



Hailo AS Tandem 15/15 dunkelgrau

3666101



- Trennung: 2-fach
- Abfalleimer: 2 x 15 l, Gesamtvolumen 30 l
- **Montageart: Bodenmontage**
- Auszugsschienen: Vollauszug
- Farbe: Metallteile silberfarben, Kunststoffteile dunkelgrau
- Produkt-Maße: B x T x H, 251 x 482 x 400 mm
- Verpackungsmaße: B x T x H, 260 x 504 x 420 mm
- Gewicht mit Verpackung: 7,15 kg



Passend für Schränke
Suitable for cabinets

30 40 45 50 60 cm



- Separation: 2-fold
- Inner bins: 2 x 15 l, Total capacity 30 l, 1 x Lid 15 l
- **Type of installation: bottom-mounted**
- Slides: full extension
- Colour: Metal parts silver-coloured, Plastic parts light-grey
- Product dimensions: W x D x H, 251 x 482 x 400 mm
- Packing dimensions: W x D x H, 260 x 504 x 420 mm
- Weight incl. packing: 7,8 kg

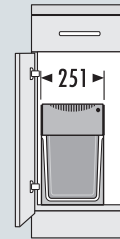
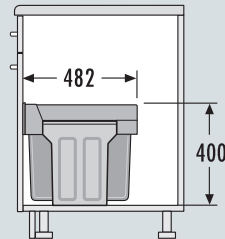

30 cm

Passend für Schränke
Suitable for cabinets

30 40 45 50 60 cm



- Separation: 2-fold
- Inner bins: 1 x 24 l, 1 x 7 l, Total capacity 31 l
- **Type of installation: bottom-mounted**
- Slides: full extension
- Colour: Metal parts silver-coloured, Plastic parts dark-grey
- Product dimensions: W x D x H, 251 x 482 x 400 mm
- Packing dimensions: W x D x H, 260 x 504 x 420 mm
- Weight incl. packing: 7,05 kg

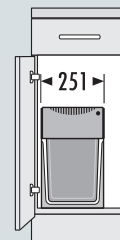
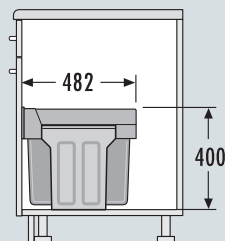

Passend für Schränke
Suitable for cabinets

30 40 45 50 60 cm



- Separation: 2-fold
- Inner bins: 2 x 15 l, Total capacity 30 l
- **Type of installation: bottom-mounted**
- Slides: full extension
- Colour: Metal parts silver-coloured, Plastic parts dark-grey
- Product dimensions: W x D x H, 251 x 482 x 400 mm
- Packing dimensions: W x D x H, 260 x 504 x 420 mm
- Weight incl. packing: 7,15 kg

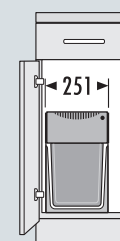
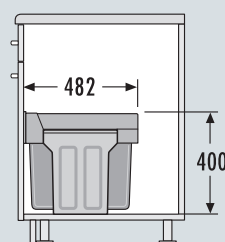

Swing



Für Schränke ab 300 mm Breite mit Drehtür For hinged door cabinets from 300 mm width

Tandem



Hailo AS Tandem 15/15 weiß

3666001



- Trennung: 2-fach
- Abfalleimer: 2 x 15 l, Gesamtvolumen 30 l
- **Montageart: Bodenmontage**
- Auszugsschienen: Vollauszug
- Farbe: Metallteile weiß, Kunststoffteile weiß
- Produkt-Maße: B x T x H, 251 x 482 x 400 mm
- Verpackungsmaße: B x T x H, 260 x 504 x 420 mm
- Gewicht mit Verpackung: 7,15 kg



Tandem



Hailo AS Tandem 15/15 dunkelgrau

3650101



- Trennung: 2-fach
- Abfalleimer: 2 x 15 l, Gesamtvolumen 30 l
- **Montageart: Bodenmontage**
- Auszugsschienen: Teilauszug
- Farbe: Metallteile silberfarben, Kunststoffteile dunkelgrau
- Produkt-Maße: B x T x H, 252 x 505 x 415 mm
- Verpackungsmaße: B x T x H, 270 x 518 x 440 mm
- Gewicht mit Verpackung: 5 kg



Terzett



Hailo AS Terzett 10/10/10/D hellgrau

3666841



- Trennung: 3-fach
- Abfalleimer: 3 x 10 l, Gesamtvolumen 30 l, 1 x Behälterdeckel 10 l
- **Montageart: Bodenmontage**
- Auszugsschienen: Vollauszug
- Farbe: Metallteile silberfarben, Kunststoffteile hellgrau
- Produkt-Maße: B x T x H, 251 x 482 x 400 mm
- Verpackungsmaße: B x T x H, 260 x 504 x 420 mm
- Gewicht mit Verpackung: 7,1 kg



Passend für Schränke
Suitable for cabinets

30 40 45 50 60 cm



- Separation: 2-fold
- Inner bins: 2 x 15 l, Total capacity 30 l
- **Type of installation: bottom-mounted**
- Slides: full extension
- Colour: Metal parts white, Plastic parts white
- Product dimensions: W x D x H, 251 x 482 x 400 mm
- Packing dimensions: W x D x H, 260 x 504 x 420 mm
- Weight incl. packing: 7,15 kg

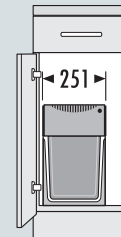
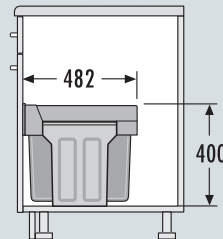

30 cm

Passend für Schränke
Suitable for cabinets

30 40 45 50 60 cm



- Separation: 2-fold
- Inner bins: 2 x 15 l, Total capacity 30 l
- **Type of installation: bottom-mounted**
- Slides: single extension
- Colour: Metal parts silver-coloured, Plastic parts dark-grey
- Product dimensions: W x D x H, 252 x 505 x 415 mm
- Packing dimensions: W x D x H, 270 x 518 x 440 mm
- Weight incl. packing: 5 kg

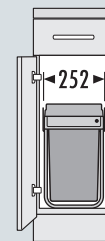
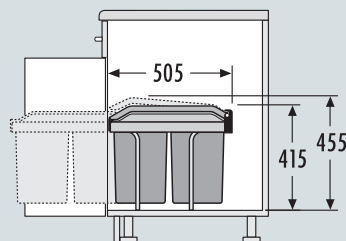

Passend für Schränke
Suitable for cabinets

30 40 45 50 60 cm



- Separation: 3-fold
- Inner bins: 3 x 10 l, Total capacity 30 l, 1 x Lid 10 l
- **Type of installation: bottom-mounted**
- Slides: full extension
- Colour: Metal parts silver-coloured, Plastic parts light-grey
- Product dimensions: W x D x H, 251 x 482 x 400 mm
- Packing dimensions: W x D x H, 260 x 504 x 420 mm
- Weight incl. packing: 7,1 kg

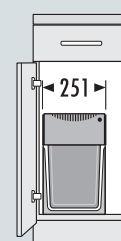
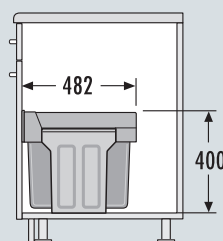

Swing



Für Schränke ab 300 mm Breite mit Drehtür For hinged door cabinets from 300 mm width

Terzett



Hailo AS Terzett 15/7/7 dunkelgrau

3666191



- Trennung: 3-fach
- Abfalleimer: 1 x 15 l, 2 x 7 l, Gesamtvolumen 29 l
- **Montageart: Bodenmontage**
- Auszugsschienen: Vollauszug
- Farbe: Metallteile silberfarben, Kunststoffteile dunkelgrau
- Produkt-Maße: B x T x H, 251 x 482 x 400 mm
- Verpackungsmaße: B x T x H, 260 x 504 x 420 mm
- Gewicht mit Verpackung: 7,1 kg



Terzett



Hailo AS Terzett 10/10/10 dunkelgrau

3666131



- Trennung: 3-fach
- Abfalleimer: 3 x 10 l, Gesamtvolumen 30 l
- **Montageart: Bodenmontage**
- Auszugsschienen: Vollauszug
- Farbe: Metallteile silberfarben, Kunststoffteile dunkelgrau
- Produkt-Maße: B x T x H, 251 x 482 x 400 mm
- Verpackungsmaße: B x T x H, 260 x 504 x 420 mm
- Gewicht mit Verpackung: 7,1 kg



Pico

Hailo AS Pico 5

3505001



- Abfalleimer: 1 x 5 l
- **Montageart: Seitenwandmontage** mit Türmitnehmer
- Farbe: Metallteile weiß, Kunststoffteile weiß
- Produkt-Maße: B x T x H, 175 x 175 x 310 mm
- Verpackungsmaße: B x T x H, 185 x 185 x 310 mm
- Gewicht mit Verpackung: 0,71 kg
- Kann links- wie rechtsseitig montiert werden

Passend für Schränke
Suitable for cabinets

30 40 45 50 60 cm



- Separation: 3-fold
- Inner bins: 1 x 15 l, 2 x 7 l, Total capacity 29 l
- **Type of installation: bottom-mounted**
- Slides: full extension
- Colour: Metal parts silver-coloured, Plastic parts dark-grey
- Product dimensions: W x D x H, 251 x 482 x 400 mm
- Packing dimensions: W x D x H, 260 x 504 x 420 mm
- Weight incl. packing: 7,1 kg

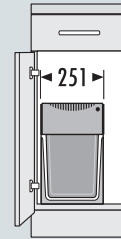
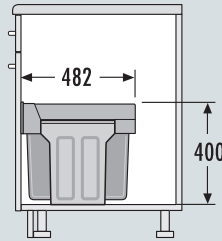

30 cm

Passend für Schränke
Suitable for cabinets

30 40 45 50 60 cm



- Separation: 3-fold
- Inner bins: 3 x 10 l, Total capacity 30 l
- **Type of installation: bottom-mounted**
- Slides: full extension
- Colour: Metal parts silver-coloured, Plastic parts dark-grey
- Product dimensions: W x D x H, 251 x 482 x 400 mm
- Packing dimensions: W x D x H, 260 x 504 x 420 mm
- Weight incl. packing: 7,1 kg

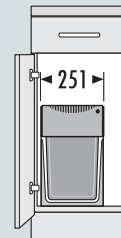
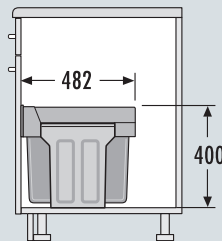

Passend für Schränke
Suitable for cabinets

30 40 45 50 60 cm



- Inner bin: 1 x 5 l
- **Type of installation: side-wall-mounted, with door follower**
- Colour: Metal parts white, Plastic parts white
- Product dimensions: W x D x H, 175 x 175 x 310 mm
- Packing dimensions: W x D x H, 185 x 185 x 310 mm
- Weight incl. packing: 0,71 kg
- May be installed on left or on right sidewall

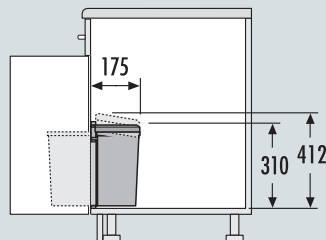

Swing



Für Schränke ab 300 mm Breite mit Drehtür
For hinged door cabinets from 300 mm width

Solo

Hailo AS Solo 20 manual

3635001

NEW



- Abfalleimer: 1 x 20 l
- **Montageart: Bodenmontage**
- Auszugsschienen: Vollauszug
- Farbe: Metall- und Kunststoffteile dunkelgrau
- Produkt-Maße: B x T x H, 245 x 427 x 396 mm
- Verpackungsmaße: B x T x H, 260 x 435 x 410 mm
- Gewicht mit Verpackung: 4,3 kg



Passend für Schränke
Suitable for cabinets

30 40 45 50 60 cm



- Inner bin: 1 x 20 l
- **Type of installation: bottom-mounted**
- Slides: full extension
- Colour: Metal parts dark-grey, plastic parts dark-grey
- Product dimensions: W x D x H, 245 x 427 x 396 mm
- Packing dimensions: W x D x H, 260 x 435 x 410 mm
- Weight incl. packing: 4,3 kg

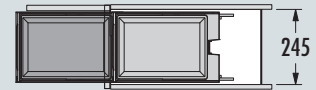
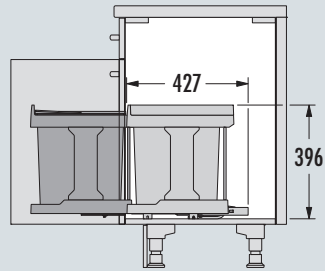

30 cm

Übrigens, wussten Sie, ...

By the way, did you know...

dass Hailo der Erfinder des
Einbau-Abfalltrennsystems ist?

that Hailo is the inventor of
the fitted waste separation system,
the original Hailo Tandem?



Slide



Für Schränke ab 300 mm Breite mit Frontauszug
For front-mount-door cabinets from 300 mm width



30 cm

Slide



Für Schränke ab 300 mm Breite mit Frontauszug
For front-mount-door cabinets from 300 mm width

Cargo Synchro

Hailo AS Cargo Synchro 300 30



- Abfalleimer: 1 x 30 l
- Montageart: Seitenwandmontage, selbstjustierend 16 - 19 mm
- **Auszugsschienen: abgedeckter, gedämpfter Selbsteinzug mit synchronisiertem Überauszug**
- Systemtiefe: 403 mm
- Herausfahrbare Systemdeckel aus Metall/Kunststoff, vollflächig belegt mit rutschfester Gummimatte
- Farbe: Metall- und Kunststoffteile dunkelgrau
- Produkt-Maße: B x T x H, 262-268 x 403 x 507 mm
- Verpackungsmaße: B x T x H, 545 x 320 x 450 mm
- Gewicht mit Verpackung: 9,4 kg

Euro Cargo S

Hailo AS Euro Cargo S 300 30



- Abfalleimer: 1 x 30 l
- Montageart: Seitenwandmontage, selbstjustierend 16 - 19 mm
- **Auszugsschienen: abgedeckter, gedämpfter Selbsteinzug**
- Systemtiefe: 448 mm
- Metallsystemdeckel
- Farbe: Metallteile silberfarben
- Produkt-Maße: B x T x H, 262-268 x 403 x 446 mm
- Verpackungsmaße: B x T x H, 510 x 345 x 415 mm
- Gewicht mit Verpackung: 8,45 kg

- Inner bin: 1 x 30 l
- Type of installation: side-wall-mounted, self-adjusting to 16 - 19 mm side walls
- Slides: covered, dampened slides with self-closing device with fully synchronized over-travel
- System-depth: 403 mm
- Pullout metal/ plastic system lid, with anti-slip rubber mat
- Colour: Metal parts powder coated dark-grey, plastic parts dark-grey
- Product dimensions: W x D x H, 262-268 x 403 x 507 mm
- Packing dimensions: W x D x H, 545 x 320 x 450 mm
- Weight incl. packing: 9,4 kg

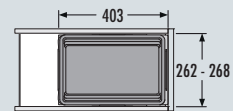
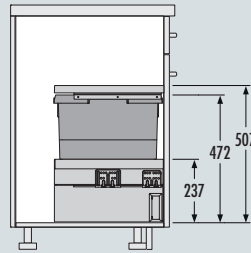

- Inner bin: 1 x 30 l
- Type of installation: side-wall-mounted, self-adjusting to 16 - 19 mm side walls
- Slides: covered, dampened slides with self-closing device
- System-depth: 448 mm
- Sheet metal system Lid
- Colour: Frame metal parts silver-coloured
- Product dimensions: W x D x H, 262-268 x 403 x 446 mm
- Packing dimensions: W x D x H, 510 x 345 x 415 mm
- Weight incl. packing: 8,45 kg

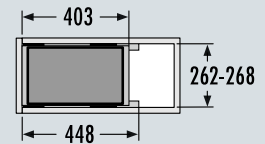
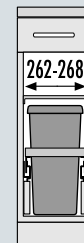
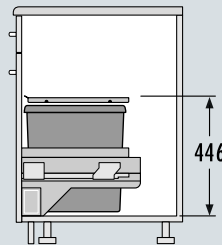

Slide



Für Schränke ab 300 mm Breite mit Frontauszug
For front-mount-door cabinets from 300 mm width

Hailo Kick and Go

Fußhebel

3691301



Fußhebel "Kick and go" für Frontauszüge
und untere Schubkästen

siehe Seite 176

Hailo Libero 2.0

Elektronischer Türöffner

3697201



Hailo Libero – Hands Free Opener

Die Öffnungsunterstützung von Hailo für ein auto-
matisches, komfortables Öffnen aller Abfalltrenn-
systeme mit Frontanbindung und aller Auszugssysteme.

Ausführliche Beschreibung Seite 172

Hailo Libero

Elektronischer Türöffner

3697101



Hailo Libero – Hands Free Opener

Die Öffnungsunterstützung von Hailo für ein auto-
matisches, komfortables Öffnen aller Abfalltrenn-
systeme mit Frontanbindung und aller Auszugssysteme.

Ausführliche Beschreibung Seite 174

Kann in Verbindung mit Metalltüren,
gerahmten Metalltüren und Metall-Sockeln
zu Funktionsstörungen führen.

Foot Pedal

Foot Pedal "Kick and go" for Front mounted door and lower drawer

More information: page 176

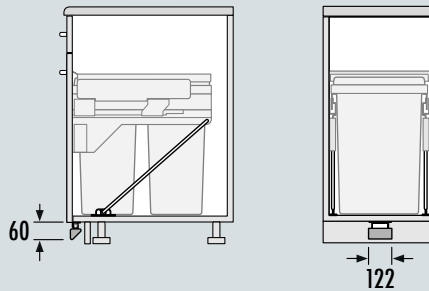

Electronic Door Opener

Hailo „Libero“ – Hands Free Opener

Hailo's electronic front-mount-door and drawer-opener „Libero“ offers an automatic, comfortable hands-free opening of all waste-recycling-systems with attached door-panel and of any common, also damped, drawer-mounted systems.

More information: page 172

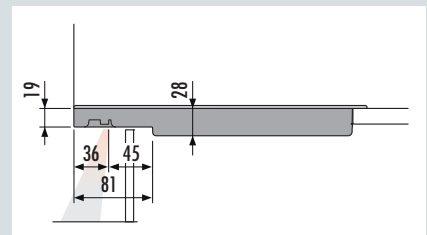
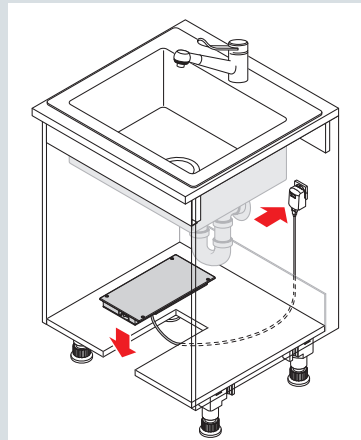

Electronic Door Opener

Hailo „Libero“ – Hands Free Opener

Hailo's electronic front-mount-door and drawer-opener „Libero“ offers an automatic, comfortable hands-free opening of all waste-recycling-systems with attached door-panel and of any common, also damped, drawer-mounted systems.

More information page 174

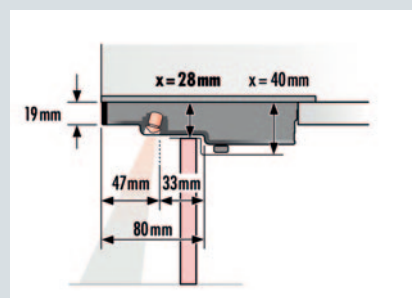

If installed behind a door-panel with a metal frame, or behind a metal cabinet-front, or above a metal plinth, malfunctions may occur.

Übrigens, wussten Sie, ...

By the way, did you know...

dass Hailo Einbautechnik viele Standards durch Innovationen (Rondo, Mono, Tandem, Cargo etc.) gesetzt hat?

that Hailo Built-In Technology has set many standards through innovation (Rondo, Mono, Tandem, Cargo etc.)?



Inset



Einsatz für Schränke ab 300 mm Breite mit Frontauszug
For common drawers from 300 mm width



30 cm

Inset



Einsatz für Schränke ab 300 mm Breite mit Frontauszug
For common drawers from 300 mm width

Euro Cargo 30

Hailo AS Euro Cargo 300 38/7



3669101

NEW



- Trennung: 2-fach
- Abfalleimer: 1 x 38 l, 1 x 7 l, Gesamtvolumen 45 l
- **Montageart: Schubkastenmontage**
- Schubkasten Nenntiefe \geq 500 mm
- Kunststoffsystemdeckel
- Farbe: Metallteile dunkelgrau, Kunststoffteile dunkelgrau
- Produkt-Maße: B x T x H, 259 x 484 x 550 mm
- Verpackungsmaße: B x T x H, 490 x 290 x 605 mm
- Gewicht mit Verpackung: 4 kg

Tandem

Hailo AS Tandem 15/15 dunkelgrau



3669001

NEW



- Trennung: 2-fach
- Abfalleimer: 2 x 15 l, Gesamtvolumen 30 l
- **Montageart: Schubkastenmontage**
- Schubkasten Nenntiefe \geq 500 mm
- Kunststoffsystemdeckel
- Farbe: Metallteile & Kunststoffteile dunkelgrau
- Produkt-Maße: B x T x H, 259 x 484 x 375 mm
- Verpackungsmaße: B x T x H, 260 x 504 x 420 mm
- Gewicht mit Verpackung: 3,1 kg

- Separation: 2-fold
- Inner bins: 1 x 38 l, 1 x 7 l, Total capacity 45 l
- **Type of installation: inside available drawer**
- Nominal drawer-depth ≥ 500 mm
- Plastic system lid
- Colour: Frame metal parts dark-grey, plastic parts dark-grey
- Product dimensions: W x D x H, 259 x 484 x 550 mm
- Packing dimensions: W x D x H, 490 x 290 x 605 mm
- Weight incl. packing: 4 kg

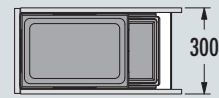
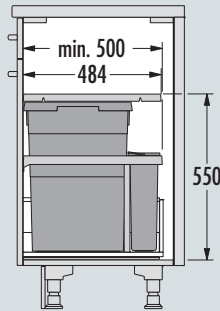

- Separation: 2-fold
- Inner bins: 2x 15 l, Total capacity 30 l
- **Type of installation: inside available drawer**
- Nominal drawer-depth ≥ 500 mm
- Plastic system lid
- Colour: Frame metal parts & plastic parts dark-grey
- Product dimensions: W x D x H, 259 x 484 x 375 mm
- Packing dimensions: W x D x H, 260 x 504 x 420 mm
- Weight incl. packing: 3,1 kg

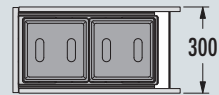
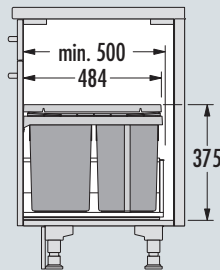



Übrigens, wussten Sie, ...

dass Hailo bereits 1953 den ersten Einbau-Abfallsammler für Küchen auf den Markt brachte?

By the way, did you know...

that Hailo already introduced the first built-in waste bins in 1953?

Swing



Für Schränke ab 400 mm Breite mit Drehtür
For hinged door cabinets from 400 mm width



40 cm

Swing



Für Schränke ab 400 mm Breite mit Drehtür
For hinged door cabinets from 400 mm width

Solo

3636001

NEW



Hailo AS Solo 20 automatic

- Abfalleimer: 1 x 20 l
- **Montageart: Bodenmontage**
- Auszugsschienen: Vollauszug mit Ausfahrautomatik
- Farbe: Metall- und Kunststoffteile dunkelgrau
- Produktmaße: B x T x H, 245 x 427 x 396 mm
- Verpackungsmaße: B x T x H, 260 x 435 x 410 mm
- Gewicht mit Verpackung: 4,3 kg



Mono

3512001



Hailo AS Mono 12 weiß

- Abfalleimer: 1 x 12 l
- **Montageart: Seitenwandmontage** mit Türmitnehmer
- Federloser, automatischer Dreh-Kipp-Deckel
- Farbe: Metallteile Stahlblech weiß, Kunststoffteile reinweiß
- Produkt-Maße: B x T x H, 290 x 304 x 295 mm
- Verpackungsmaße: B x T x H, 293 x 298 x 298 mm
- Gewicht mit Verpackung: 1,85 kg
- Kann links- wie rechtsseitig montiert werden

Mono

3512011



Hailo AS Mono 12 Edelstahl/weiß

- Abfalleimer: 1 x 12 l
- **Montageart: Seitenwandmontage** mit Türmitnehmer
- Federloser, automatischer Dreh-Kipp-Deckel
- Farbe: Metallteile Edelstahl, Kunststoffteile reinweiß
- Produkt-Maße: B x T x H, 290 x 304 x 295 mm
- Verpackungsmaße: B x T x H, 293 x 298 x 298 mm
- Gewicht mit Verpackung: 1,85 kg
- Kann links- wie rechtsseitig montiert werden

Passend für Schränke 40 45 50 60 cm
Suitable for cabinets



- Inner bin: 1 x 20 l
- **Type of installation: bottom-mounted**
- Slides: full extension with automatic door-follower
- Colour: Metal parts dark-grey, Plastic parts dark-grey
- Product dimensions: W x D x H, 245 x 427 x 396 mm
- Packing dimensions: W x D x H, 260 x 435 x 410 mm
- Weight incl. packing: 4,3 kg

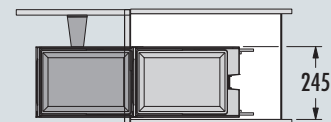
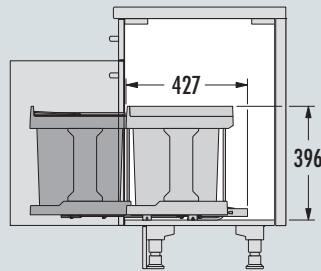

40 cm

Passend für Schränke 40 45 50 60 cm
Suitable for cabinets



- Inner bin: 1 x 12 l
- **Type of installation: side-wall-mounted, with door follower**
- Springless turn and tilt lid
- Colour: Metal parts sheet steel white, Plastic parts pure white
- Product dimensions: W x D x H, 290 x 304 x 295 mm
- Packing dimensions: W x D x H, 293 x 298 x 298 mm
- Weight incl. packing: 1,85 kg
- May be installed on left or on right sidewall

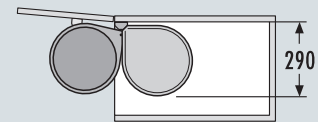
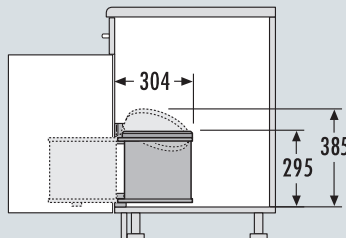

Passend für Schränke 40 45 50 60 cm
Suitable for cabinets



- Inner bin: 1 x 12 l
- **Type of installation: side-wall-mounted, with door follower**
- Springless turn and tilt lid
- Colour: Metal parts stainless steel, Plastic parts pure white
- Product dimensions: W x D x H, 290 x 304 x 295 mm
- Packing dimensions: W x D x H, 293 x 298 x 298 mm
- Weight incl. packing: 1,85 kg
- May be installed on left or on right sidewall

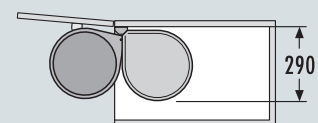
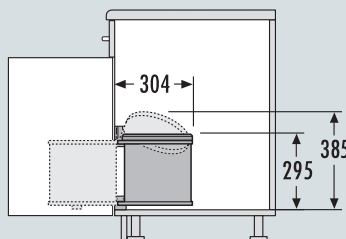

Swing



Für Schränke ab 400 mm Breite mit Drehtür
For hinged door cabinets from 400 mm width

Mono

3512031



Hailo AS Mono 12 Edelstahl/schwarz

- Abfalleimer: 1 x 12 l
- **Montageart:** Seitenwandmontage mit Türmitnehmer
- Federloser, automatischer Dreh-Kipp-Deckel
- Farbe: Metallteile Edelstahl, Kunststoffteile schwarz
- Produkt-Maße: B x T x H, 290 x 304 x 295 mm
- Verpackungsmaße: B x T x H, 293 x 298 x 298 mm
- Gewicht mit Verpackung: 1,85 kg
- Kann links- wie rechtsseitig montiert werden

Mono

3515001



Hailo AS Mono 15 weiß

- Abfalleimer: 1 x 15 l
- **Montageart:** Seitenwandmontage mit Türmitnehmer
- Federloser, automatischer Dreh-Kipp-Deckel
- Farbe: Metallteile Stahlblech weiß, Kunststoffteile reinweiß
- Produkt-Maße: B x T x H, 290 x 304 x 365 mm
- Verpackungsmaße: B x T x H, 298 x 298 x 363 mm
- Gewicht mit Verpackung: 2,05 kg
- Kann links- wie rechtsseitig montiert werden

Mono

3515071



NEW

Hailo AS Mono 15 dunkelgrau/schwarz

- Abfalleimer: 1 x 15 l
- **Montageart:** Seitenwandmontage mit Türmitnehmer
- Federloser, automatischer Dreh-Kipp-Deckel
- Farbe: Metallteile dunkelgrau, Kunststoffteile schwarz
- Produkt-Maße: B x T x H, 290 x 304 x 365 mm
- Verpackungsmaße: B x T x H, 298 x 298 x 363 mm
- Gewicht mit Verpackung: 2,05 kg
- Kann links- wie rechtsseitig montiert werden

Passend für Schränke 40 45 50 60 cm
Suitable for cabinets



- Inner bin: 1 x 12 l
- **Type of installation:** side-wall-mounted, with door follower
- Springless turn and tilt lid
- Colour: Metal parts stainless steel, Plastic parts black
- Product dimensions: W x D x H, 290 x 304 x 295 mm
- Packing dimensions: W x D x H, 293 x 298 x 298 mm
- Weight incl. packing: 1,85 kg
- May be installed on left or on right sidewall

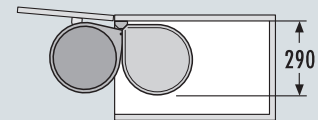
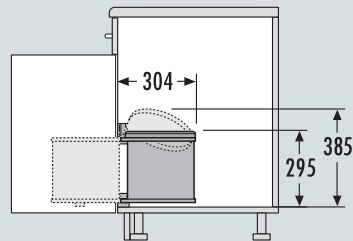

40 cm

Passend für Schränke 40 45 50 60 cm
Suitable for cabinets



- Inner bin: 1 x 15 l
- **Type of installation:** side-wall-mounted, with door follower
- Springless turn and tilt lid
- Colour: Metal parts sheet steel white, Plastic parts pure white
- Product dimensions: W x D x H, 290 x 304 x 365 mm
- Packing dimensions: W x D x H, 298 x 298 x 363 mm
- Weight incl. packing: 2,05 kg
- May be installed on left or on right sidewall

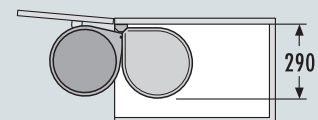
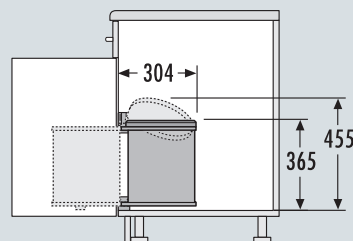

Passend für Schränke 40 45 50 60 cm
Suitable for cabinets



- Inner bin: 1 x 15 l
- **Type of installation:** side-wall-mounted, with door follower
- Springless turn and tilt lid
- Colour: Metal parts dark-grey, Plastic parts black
- Product dimensions: W x D x H, 290 x 304 x 365 mm
- Packing dimensions: W x D x H, 298 x 298 x 363 mm
- Weight incl. packing: 2,05 kg
- May be installed on left or on right sidewall

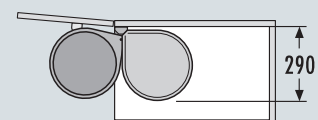
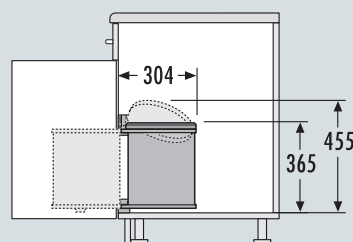

Swing



Für Schränke ab 400 mm Breite mit Drehtür
For hinged door cabinets from 400 mm width

Mono

3515011



Hailo AS Mono 15 Edelstahl/weiß

- Abfalleimer: 1 x 15 l
- **Montageart:** Seitenwandmontage mit Türmitnehmer
- Federloser, automatischer Dreh-Kipp-Deckel
- Farbe: Metallteile Edelstahl, Kunststoffteile reinweiß
- Produkt-Maße: B x T x H, 290 x 304 x 365 mm
- Verpackungsmaße: B x T x H, 298 x 298 x 363 mm
- Gewicht mit Verpackung: 2,05 kg
- Kann links- wie rechtsseitig montiert werden

Mono

3515031



Hailo AS Mono 15 Edelstahl/schwarz

- Abfalleimer: 1 x 15 l
- **Montageart:** Seitenwandmontage mit Türmitnehmer
- Federloser, automatischer Dreh-Kipp-Deckel
- Farbe: Metallteile Edelstahl, Kunststoffteile schwarz
- Produkt-Maße: B x T x H, 290 x 304 x 365 mm
- Verpackungsmaße: B x T x H, 298 x 298 x 363 mm
- Gewicht mit Verpackung: 2,05 kg
- Kann links- wie rechtsseitig montiert werden

Big Box

3715101



Hailo AS Big Box 15 Edelstahl/braun

- Abfalleimer: 1 x 15 l
- **Montageart:** Seitenwandmontage mit Türmitnehmer
- Automatischer Feder-Hubdeckel
- Farbe: Metallteile Edelstahl, Kunststoffteile braun
- Produkt-Maße: B x T x H, 306 x 306 x 335 mm
- Verpackungsmaße: B x T x H, 298 x 298 x 363 mm
- Gewicht mit Verpackung: 2,5 kg
- Kann links- wie rechtsseitig montiert werden

ACHTUNG: nicht geeignet für gedämpfte Scharniere.

Passend für Schränke 40 45 50 60 cm
Suitable for cabinets



- Inner bin: 1 x 15 l
- **Type of installation:** side-wall-mounted, with door follower
- Springless turn and tilt lid
- Colour: Metal parts stainless steel, Plastic parts pure white
- Product dimensions: W x D x H, 290 x 304 x 365 mm
- Packing dimensions: W x D x H, 298 x 298 x 363 mm
- Weight incl. packing: 2,05 kg
- May be installed on left or on right sidewall

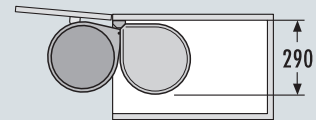
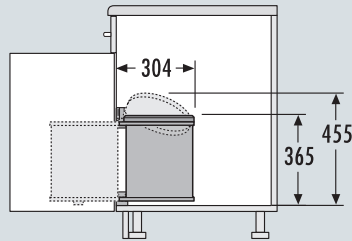

40 cm

Passend für Schränke 40 45 50 60 cm
Suitable for cabinets



- Inner bin: 1 x 15 l
- **Type of installation:** side-wall-mounted, with door follower
- Springless turn and tilt lid
- Colour: Metal parts stainless steel, Plastic parts black
- Product dimensions: W x D x H, 290 x 304 x 365 mm
- Packing dimensions: W x D x H, 298 x 298 x 363 mm
- Weight incl. packing: 2,05 kg
- May be installed on left or on right sidewall

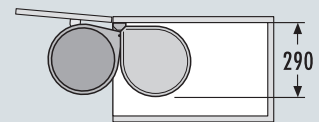
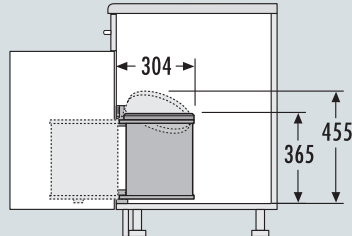

Passend für Schränke 40 45 50 60 cm
Suitable for cabinets



- Inner bin: 1 x 15 l
- **Type of installation:** side-wall-mounted, with door follower
- Automatic spring-loaded, lifted lid
- Colour: Metal parts stainless steel, Plastic parts brown
- Product dimensions: W x D x H, 306 x 306 x 335 mm
- Packing dimensions: W x D x H, 298 x 298 x 363 mm
- Weight incl. packing: 2,5 kg
- May be installed on left or on right sidewall

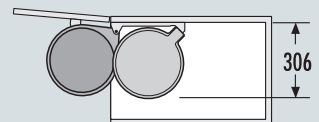
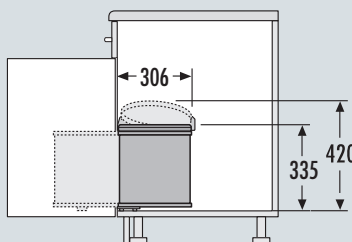

Attention! Not suitable in combination with dampened door hinges

Swing



Für Schränke ab 400 mm Breite mit Drehtür
For hinged door cabinets from 400 mm width

Big Box

3715191



Hailo AS Big Box 15 Edelstahl/weiß

- Abfalleimer: 1 x 15 l
- **Montageart: Seitenwandmontage** mit Türmitnehmer
- Automatischer Feder-Hubdeckel
- Farbe: Metallteile Edelstahl, Kunststoffteile weiß
- Produkt-Maße: B x T x H, 306 x 306 x 335 mm
- Verpackungsmaße: B x T x H, 298 x 298 x 363 mm
- Gewicht mit Verpackung: 2,5 kg
- Kann links- wie rechtsseitig montiert werden

ACHTUNG: nicht geeignet für gedämpfte Scharniere.

Big Box

3715211



Hailo AS Big Box 15 silber/schwarz

- Abfalleimer: 1 x 15 l
- **Montageart: Seitenwandmontage** mit Türmitnehmer
- Automatischer Feder-Hubdeckel
- Farbe: Metallteile Stahlblech silberfarben, Kunststoffteile schwarz
- Produkt-Maße: B x T x H, 306 x 306 x 335 mm
- Verpackungsmaße: B x T x H, 298 x 298 x 363 mm
- Gewicht mit Verpackung: 2,5 kg
- Kann links- wie rechtsseitig montiert werden

ACHTUNG: nicht geeignet für gedämpfte Scharniere.

Big Box

3715901



Hailo AS Big Box 15 weiß

- Abfalleimer: 1 x 15 l
- **Montageart: Seitenwandmontage** mit Türmitnehmer
- Automatischer Feder-Hubdeckel
- Farbe: Metallteile Stahlblech weiß, Kunststoffteile weiß
- Produkt-Maße: B x T x H, 306 x 306 x 335 mm
- Verpackungsmaße: B x T x H, 298 x 298 x 363 mm
- Gewicht mit Verpackung: 2,5 kg
- Kann links- wie rechtsseitig montiert werden

ACHTUNG: nicht geeignet für gedämpfte Scharniere.

Passend für Schränke 40 45 50 60 cm
Suitable for cabinets



- Inner bin: 1 x 15 l
- **Type of installation:** side-wall-mounted, with door follower
- Automatic spring-loaded, lifted lid
- Colour: Metal parts stainless steel, Plastic parts white
- Product dimensions: W x D x H, 306 x 306 x 335 mm
- Packing dimensions: W x D x H, 298 x 298 x 363 mm
- Weight incl. packing: 2,5 kg
- May be installed on left or on right sidewall

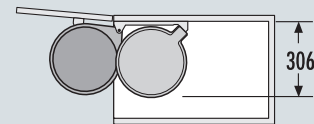
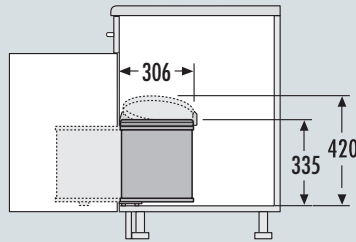

40 cm

Attention! Not suitable in combination with dampened door hinges

Passend für Schränke 40 45 50 60 cm
Suitable for cabinets



- Inner bin: 1 x 15 l
- **Type of installation:** side-wall-mounted, with door follower
- Automatic spring-loaded, lifted lid
- Colour: Metal parts sheet steel silver-coated, Plastic parts black
- Product dimensions: W x D x H, 306 x 306 x 335 mm
- Packing dimensions: W x D x H, 298 x 298 x 363 mm
- Weight incl. packing: 2,5 kg
- May be installed on left or on right sidewall

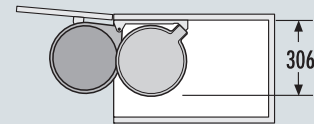
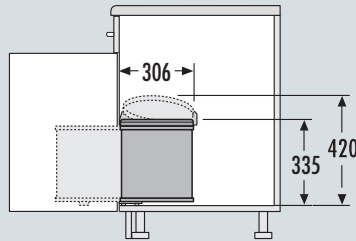

Attention! Not suitable in combination with dampened door hinges

Passend für Schränke 40 45 50 60 cm
Suitable for cabinets



- Inner bin: 1 x 15 l
- **Type of installation:** side-wall-mounted, with door follower
- Automatic spring-loaded, lifted lid
- Colour: Metal parts sheet steel white, Plastic parts white
- Product dimensions: W x D x H, 306 x 306 x 335 mm
- Packing dimensions: W x D x H, 298 x 298 x 363 mm
- Weight incl. packing: 2,5 kg
- May be installed on left or on right sidewall

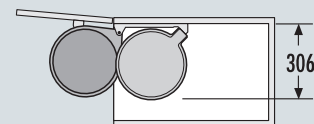
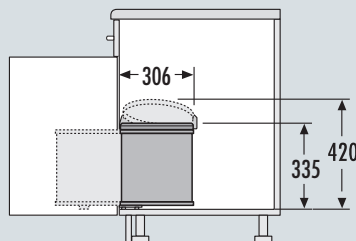

Attention! Not suitable in combination with dampened door hinges

Swing



Für Schränke ab 400 mm Breite mit Drehtür
For hinged door cabinets from 400 mm width

Big Box

3725101



Hailo AS Big Box 15 Edelstahl/braun

- Abfalleimer: 1 x 15 l
 - **Montageart: Seitenwandmontage** mit Türmitnehmer
 - Automatischer Feder-Hubdeckel
 - Farbe: Metallteile Edelstahl, Deckel Alu, Kunststoffteile braun
 - Produkt-Maße: B x T x H, 306 x 306 x 335 mm
 - Verpackungsmaße: B x T x H, 298 x 298 x 363 mm
 - Gewicht mit Verpackung: 2,5 kg
 - Kann links- wie rechtsseitig montiert werden
- ACHTUNG: nicht geeignet für gedämpfte Scharniere.

Big Box

3720001



Hailo AS Big Box 20 weiß/braun

- Abfalleimer: 1 x 20 l
 - **Montageart: Seitenwandmontage** mit Türmitnehmer
 - Automatischer Feder-Hubdeckel
 - Farbe: Metallteile Stahlblech Weiß, Deckel Alu, Kunststoffteile braun
 - Produkt-Maße: B x T x H, 306 x 306 x 450 mm
 - Verpackungsmaße: B x T x H, 295 x 295 x 431 mm
 - Gewicht mit Verpackung: 2,8 kg
 - Kann links- wie rechtsseitig montiert werden
- ACHTUNG: nicht geeignet für gedämpfte Scharniere.

Big Box

3720101



Hailo AS Big Box 20 Edelstahl/braun

- Abfalleimer: 1 x 20 l
 - **Montageart: Seitenwandmontage** mit Türmitnehmer
 - Automatischer Feder-Hubdeckel
 - Farbe: Metallteile Edelstahl, Deckel Alu, Kunststoffteile braun
 - Produkt-Maße: B x T x H, 306 x 306 x 450 mm
 - Verpackungsmaße: B x T x H, 295 x 295 x 431 mm
 - Gewicht mit Verpackung: 2,8 kg
 - Kann links- wie rechtsseitig montiert werden
- ACHTUNG: nicht geeignet für gedämpfte Scharniere.

Passend für Schränke 40 45 50 60 cm
Suitable for cabinets



- Inner bin: 1 x 15 l
- **Type of installation:** side-wall-mounted, with door follower
- Automatic spring-loaded, lifted lid
- Colour: Metal parts stainless steel, Lid Aluminium, Plastic parts brown
- Product dimensions: W x D x H, 306 x 306 x 335 mm
- Packing dimensions: W x D x H, 298 x 298 x 363 mm
- Weight incl. packing: 2,5 kg
- May be installed on left or on right sidewall

Attention! Not suitable in combination with dampened door hinges

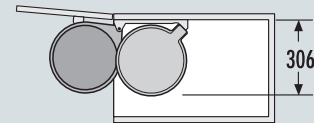
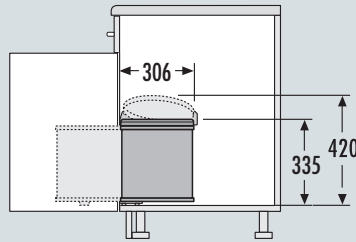

40 cm

Passend für Schränke 40 45 50 60 cm
Suitable for cabinets



- Inner bin: 1 x 20 l
- **Type of installation:** side-wall-mounted, with door follower
- Automatic spring-loaded, lifted lid
- Colour: Metal parts sheet steel white, Lid Aluminium, Plastic parts brown
- Product dimensions: W x D x H, 306 x 306 x 450 mm
- Packing dimensions: W x D x H, 295 x 295 x 431 mm
- Weight incl. packing: 2,8 kg
- May be installed on left or on right sidewall

Attention! Not suitable in combination with dampened door hinges

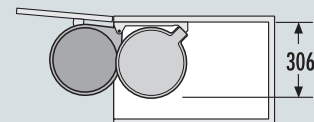
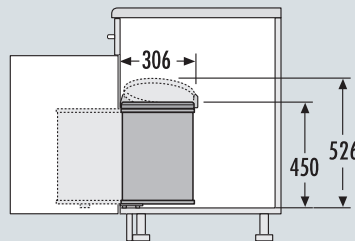

Passend für Schränke 40 45 50 60 cm
Suitable for cabinets



- Inner bin: 1 x 20 l
- **Type of installation:** side-wall-mounted, with door follower
- Automatic spring-loaded, lifted lid
- Colour: Metal parts stainless steel, Lid Aluminium, Plastic parts brown
- Product dimensions: W x D x H, 306 x 306 x 450 mm
- Packing dimensions: W x D x H, 295 x 295 x 431 mm
- Weight incl. packing: 2,8 kg
- May be installed on left or on right sidewall

Attention! Not suitable in combination with dampened door hinges

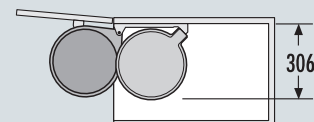
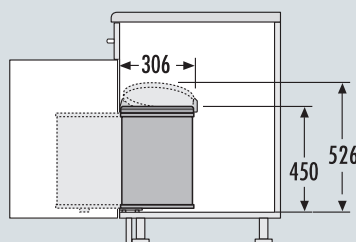

Swing



Für Schränke ab 400 mm Breite mit Drehtür
For hinged door cabinets from 400 mm width

Big Box

3720211



Hailo AS Big Box 20 silber/schwarz

- Abfalleimer: 1 x 20 l
- **Montageart: Seitenwandmontage** mit Türmitnehmer
- Automatischer Feder-Hubdeckel
- Farbe: Metallteile Stahlblech silberfarben, Kunststoffteile schwarz
- Produkt-Maße: B x T x H, 306 x 306 x 450 mm
- Verpackungsmaße: B x T x H, 295 x 295 x 431 mm
- Gewicht mit Verpackung: 2,8 kg
- Kann links- wie rechtsseitig montiert werden

ACHTUNG: nicht geeignet für gedämpfte Scharniere.

Easy Cargo

3668401



Hailo AS Easy Cargo 42

- Abfalleimer: 1 x 42 l
- **Montageart: Bodenmontage**
- Auszugsschienen: Vollauszug
- Praktische Ablagemulde im Deckel integriert
- Farbe: Metallteile silberfarben, Kunststoffteile hellgrau
- Produkt-Maße: B x T x H, 320 x 466 x 542 mm
- Verpackungsmaße: B x T x H, 345 x 510 x 560 mm
- Gewicht mit Verpackung: 8,1 kg



Easy Cargo

3668421



Hailo AS Easy Cargo 42

- Abfalleimer: 1 x 42 l
- **Montageart: Bodenmontage**
- Auszugsschienen: Vollauszug
- Beutelhalter zum Fixieren von Müllbeuteln wie zB. „Gelber Sack“
- Praktische Ablagemulde im Deckel integriert
- Farbe: Metallteile silberfarben, Kunststoffteile hellgrau
- Produkt-Maße: B x T x H, 320 x 466 x 542 mm
- Verpackungsmaße: B x T x H, 345 x 510 x 560 mm
- Gewicht mit Verpackung: 8,4 kg



Passend für Schränke
Suitable for cabinets

40 45 50 60 cm



- Inner bin: 1 x 20 l
- **Type of installation: side-wall-mounted, with door follower**
- Automatic spring-loaded, lifted lid
- Colour: Metal parts sheet steel silver-coated, Aluminium-Look-Plastic parts black
- Product dimensions: W x D x H, 306 x 306 x 450 mm
- Packing dimensions: W x D x H, 295 x 295 x 431 mm
- Weight incl. packing: 2,8 kg
- May be installed on left or on right sidewall

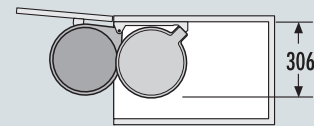
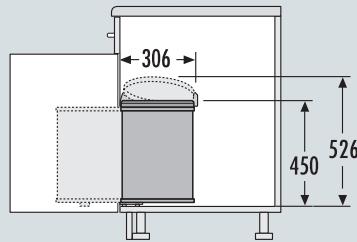

40 cm

Attention! Not suitable in combination with dampened door hinges

Passend für Schränke
Suitable for cabinets

40 45 50 60 cm



- Inner bin: 1 x 42 l
- **Type of installation: bottom-mounted**
- Slides: full extension
- Practical storage area integrated in the lid
- Colour: Metal parts silver-coloured, Plastic parts light grey
- Product dimensions: W x D x H, 320 x 466 x 542 mm
- Packing dimensions: W x D x H, 345 x 510 x 560 mm
- Weight incl. packing: 8,1 kg

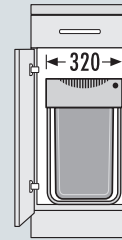
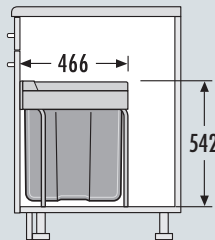

Passend für Schränke
Suitable for cabinets

40 45 50 60 cm



- Inner bin: 1 x 42 l
- **Type of installation: bottom-mounted**
- Slides: full extension
- Bagholder to fix trash bag
- Practical storage area integrated in the lid
- Colour: Metal parts silver-coloured, Plastic parts light grey
- Product dimensions: W x D x H, 320 x 466 x 542 mm
- Packing dimensions: W x D x H, 345 x 510 x 560 mm
- Weight incl. packing: 8,4 kg

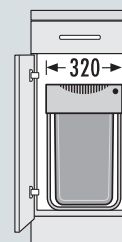
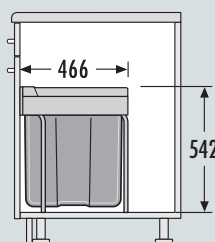

Swing



Für Schränke ab 400 mm Breite mit Drehtür For hinged door cabinets from 400 mm width

Tandem



Hailo AS Tandem 15/15/KS hellgrau



3666801

- Trennung: 2-fach
- Abfalleimer: 2 x 15 l, Gesamtvolumen 30 l
- **Montageart: Bodenmontage**
- Auszugsschienen: Vollauszug
- Mit integriertem Kehr-Set
- Farbe: Metallteile silberfarben, Kunststoffteile hellgrau
- Produkt-Maße: B x T x H, 302 x 482 x 400 mm
- Verpackungsmaße: B x T x H, 260 x 504 x 420 mm
- Gewicht mit Verpackung: 7,8 kg



Terzett

Hailo AS Terzett 10/10/10/KS hellgrau



3666831

- Trennung: 3-fach
- Abfalleimer: 3 x 10 l, Gesamtvolumen 30 l
- **Montageart: Bodenmontage**
- Auszugsschienen: Vollauszug
- Mit integriertem Kehr-Set
- Farbe: Metallteile silberfarben, Kunststoffteile hellgrau
- Produkt-Maße: B x T x H, 302 x 482 x 400 mm
- Verpackungsmaße: B x T x H, 260 x 504 x 420 mm
- Gewicht mit Verpackung: 7,8 kg



Raumspär Tandem

Hailo AS Raumspär Tandem 18/18



3640001

- Trennung: 2-fach
- Abfalleimer: 2 x 18 l, Gesamtvolumen 36 l
- **Montageart: Bodenmontage**
- Auszugsschienen: Teilauszug
- Farbe: Metallteile silberfarben, Kunststoffteile grau/schwarz
- Produkt-Maße: B x T x H, 346 x 470 x 320 mm
- Verpackungsmaße: B x T x H, 360 x 490 x 360 mm
- Gewicht mit Verpackung: 4,8 kg



Passend für Schränke
Suitable for cabinets

40 45 50 60 cm



- Separation: 2-fold
- Inner bins: 2 x 15 l, Total capacity 30 l
- **Type of installation: bottom-mounted**
- Slides: full extension
- Equipped with a dust-pan and a brush
- Colour: Metal parts silver-coloured, Plastic parts light-grey
- Product dimensions: W x D x H, 302 x 482 x 400 mm
- Packing dimensions: W x D x H, 260 x 504 x 420 mm
- Weight incl. packing: 7,8 kg

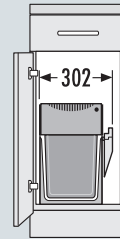
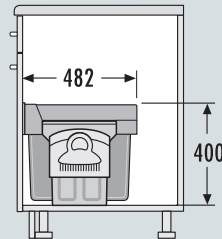

40 cm

Passend für Schränke
Suitable for cabinets

40 45 50 60 cm



- Separation: 3-fold
- Inner bins: 3 x 10 l, Total capacity 30 l
- **Type of installation: bottom-mounted**
- Slides: full extension
- Equipped with a dust-pan and a brush
- Colour: Metal parts silver-coloured, Plastic parts light-grey
- Product dimensions: W x D x H, 302 x 482 x 400 mm
- Packing dimensions: W x D x H, 260 x 504 x 420 mm
- Weight incl. packing: 7,8 kg

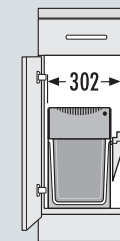
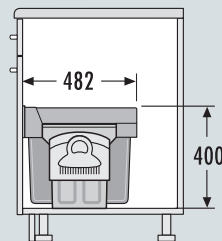

Passend für Schränke
Suitable for cabinets

40 45 50 60 cm



- Separation: 2-fold
- Inner bins: 2 x 18 l, Total capacity 36 l
- **Type of installation: bottom-mounted**
- Slides: single extension
- Colour: Metal parts silver-coloured, Plastic parts grey/black
- Product dimensions: W x D x H, 346 x 470 x 320 mm
- Packing dimensions: W x D x H, 360 x 490 x 360 mm
- Weight incl. packing: 4,8 kg

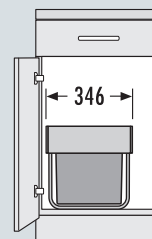
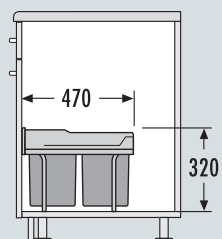

Swing



Für Schränke ab 400 mm Breite mit Drehtür
For hinged door cabinets from 400 mm width

Raumspär Tandem

Hailo AS Raumspär Tandem 18/18

3641121



- Trennung: 2-fach
- Abfalleimer: 2 x 18 l, Gesamtvolumen 36 l
- **Montageart: Bodenmontage**
- Auszugsschienen: Vollauszug
- Farbe: Metallteile silberfarben, Kunststoffteile hellgrau
- Produkt-Maße: B x T x H, 346 x 475 x 336 mm
- Verpackungsmaße: B x T x H, 360 x 490 x 370 mm
- Gewicht mit Verpackung: 5 kg



Raumspär Tandem

Hailo AS Raumspär Tandem 18/8,5/8,5/D

3642131



- Trennung: 3-fach
- Abfalleimer: 1 x 18 l, 2 x 8,5 l, Gesamtvolumen 35 l, 1 x Behälterdeckel 8,5 l
- **Montageart: Bodenmontage**
- Auszugsschienen: Vollauszug
- Farbe: Metallteile silberfarben, Kunststoffteile hellgrau
- Produkt-Maße: B x T x H, 346 x 475 x 336 mm
- Verpackungsmaße: B x T x H, 360 x 490 x 370 mm
- Gewicht mit Verpackung: 6,0 kg



Raumspär Tandem

Hailo AS Raumspär Tandem 8,5/8,5/8,5/8,5/D

3643141



- Trennung: 4-fach
- Abfalleimer: 4 x 8,5 l, Gesamtvolumen 34 l, 1 x Behälterdeckel 8,5 l
- **Montageart: Bodenmontage**
- Auszugsschienen: Vollauszug
- Farbe: Metallteile silberfarben, Kunststoffteile hellgrau
- Produkt-Maße: B x T x H, 346 x 475 x 336 mm
- Verpackungsmaße: B x T x H, 360 x 490 x 370 mm
- Gewicht mit Verpackung: 6,3 kg



Passend für Schränke 40 45 50 60 cm
Suitable for cabinets



- Separation: 2-fold
- Inner bins: 2 x 18 l, Total capacity 36 l
- **Type of installation: bottom-mounted**
- Slides: full extension
- Colour: Metal parts silver-coloured, Plastic parts light grey
- Product dimensions: W x D x H, 346 x 475 x 336 mm
- Packing dimensions: W x D x H, 360 x 490 x 370 mm
- Weight incl. packing: 5 kg

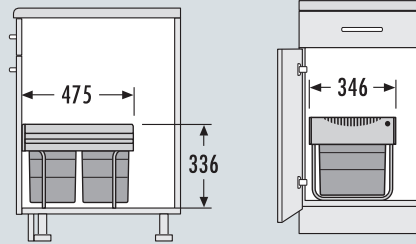

40 cm

Passend für Schränke 40 45 50 60 cm
Suitable for cabinets



- Separation: 3-fold
- Inner bins: 1 x 18 l, 2 x 8.5 l, Total capacity 35 l, 1 x Lid 8.5 l
- **Type of installation: bottom-mounted**
- Slides: full extension
- Colour: Metal parts silver-coloured, Plastic parts light grey
- Product dimensions: W x D x H, 346 x 475 x 336 mm
- Packing dimensions: W x D x H, 360 x 490 x 370 mm
- Weight incl. packing: 6,0 kg

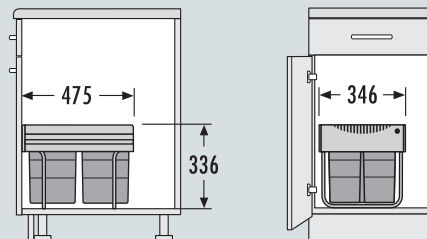

Passend für Schränke 40 45 50 60 cm
Suitable for cabinets



- Separation: 4-fold
- Inner bins: 4 x 8.5 l, Total capacity 34 l, 1 x Lid 8.5 l
- **Type of installation: bottom-mounted**
- Slides: full extension
- Colour: Metal parts silver-coloured, Plastic parts light grey
- Product dimensions: W x D x H, 346 x 475 x 336 mm
- Packing dimensions: W x D x H, 360 x 490 x 370 mm
- Weight incl. packing: 6,3 kg

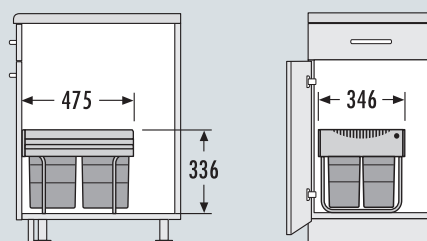

Swing



Für Schränke ab 400 mm Breite mit Drehtür
For hinged door cabinets from 400 mm width

Raumspär Tandem Comfort

Hailo AS Raumspär Tandem Comfort 20/20/KS

3641221

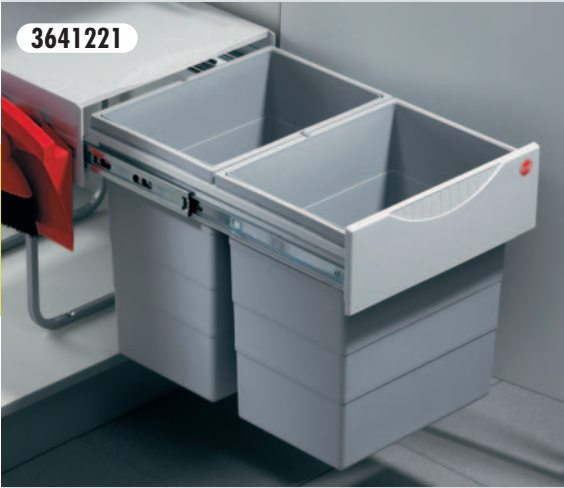

- Trennung: 2-fach
- Abfalleimer: 2 x 20 l, Gesamtvolumen 40 l
- **Montageart: Bodenmontage**
- Auszugsschienen: Vollauszug
- Mit integriertem Kehr-Set
- Farbe: Metallteile silberfarben, Kunststoffteile hellgrau
- Produkt-Maße: B x T x H, 346 x 475 x 392 mm
- Verpackungsmaße: B x T x H, 360 x 490 x 410 mm
- Gewicht mit Verpackung: 6 kg



Raumspär Tandem Comfort

Hailo AS Raumspär Tandem Comfort 20/10/10/D/KS

3642231



- Trennung: 3-fach
- Abfalleimer: 1 x 20 l, 2 x 10 l, Gesamtvolumen 40 l,
1 x Behälterdeckel 10 l
- **Montageart: Bodenmontage**
- Auszugsschienen: Vollauszug
- Mit integriertem Kehr-Set
- Farbe: Metallteile silberfarben, Kunststoffteile hellgrau
- Produkt-Maße: B x T x H, 346 x 475 x 392 mm
- Verpackungsmaße: B x T x H, 360 x 490 x 410 mm
- Gewicht mit Verpackung: 7 kg



Passend für Schränke
Suitable for cabinets

40 45 50 60 cm



- Separation: 2-fold
- Inner bins: 2 x 20 l, Total capacity 40 l
- **Type of installation: bottom-mounted**
- Slides: full extension
- Equipped with a dust-pan and brush
- Colour: Metal parts silver-coloured, Plastic parts light grey
- Product dimensions: W x D x H, 346 x 475 x 392 mm
- Packing dimensions: W x D x H, 360 x 490 x 410 mm
- Weight incl. packing: 6 kg

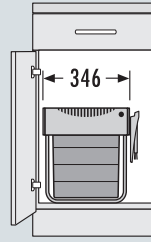
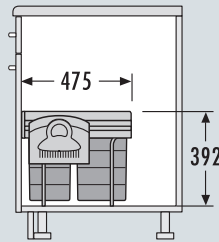

40 cm

Passend für Schränke
Suitable for cabinets

40 45 50 60 cm



- Separation: 3-fold
- Inner bins: 1 x 20 l, 2 x 10 l, Total capacity 40 l,
1 x Lid 10 l
- **Type of installation: bottom-mounted**
- Slides: full extension
- Equipped with a dust-pan and brush
- Colour: Metal parts silver-coloured, Plastic parts light grey
- Product dimensions: W x D x H, 346 x 475 x 392 mm
- Packing dimensions: W x D x H, 360 x 490 x 410 mm
- Weight incl. packing: 7 kg

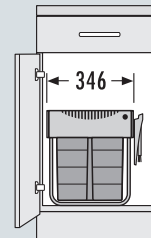
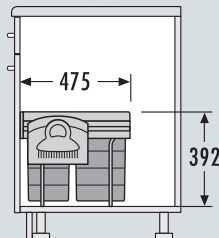

Übrigens, wussten Sie, ...

dass Hailo bereits 1993 ein Abfalltrennsystem mit Frontanbindung und Auszugschienen auf den Markt brachte und somit als Pionier dieser Systeme gilt.

By the way, did you know...

that Hailo as a pioneer launched a waste separation system with front attachment and drawer slides in 1993 ?

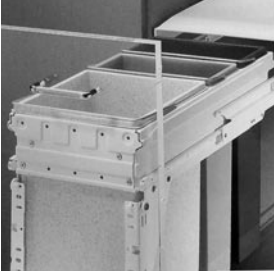

Slide



Für Schränke ab 400 mm Breite mit Frontauszug
For front-mount-door cabinets from 400 mm width



40 cm

Slide



Für Schränke ab 400 mm Breite mit Frontauszug
For front-mount-door cabinets from 400 mm width

Euro Cargo 40



3619421

NEW



Hailo AS Euro Cargo 400 38/7

- Trennung: 2-fach
- Abfalleimer: 1 x 38 l, 1 x 7 l, Gesamtvolumen 45 l
- Montageart: Seitenwandmontage, selbstjustierend 16 - 19 mm
- **Auszugsschienen: abgedeckter, gedämpfter Selbsteinzug mit synchronisiertem Überauszug**
- Systemtiefe 528 mm
- Metallsystemdeckel
- Farbe: Metallteile silberfarben, Kunststoffteile hellgrau
- Produkt-Maße: B x T x H, 362-368 x 528 x 545 mm
- Verpackungsmaße: B x T x H, 490 x 320 x 620 mm
- Gewicht mit Verpackung: 13,6 kg

Bottom Mount



3616411



Hailo AS Bottom Mount 400 24/D/24/D

- Trennung: 2-fach
- Abfalleimer: 2 x 24 l, Gesamtvolumen 48 l, 2 Behälterdeckel 24 l
- Montageart: Bodenmontage
- **Auszugsschienen: gedämpfter Selbsteinzug**
- Systemtiefe 530 mm
- Farbe: Metallteile silberfarben, Kunststoffteile hellgrau
- Produkt-Maße: B x T x H, 350 x 530 x 385 mm
- Verpackungsmaße: B x T x H, 365 x 355 x 585 mm
- Gewicht mit Verpackung: 9,9 kg

Bottom Mount



3616401



Hailo AS Bottom Mount 400 29/D/29/D

- Trennung: 2-fach
- Abfalleimer: 2 x 29 l, Gesamtvolumen 58 l, 2 Behälterdeckel 29 l
- Montageart: Bodenmontage
- **Auszugsschienen: gedämpfter Selbsteinzug**
- Systemtiefe 530 mm
- Farbe: Metallteile silberfarben, Kunststoffteile hellgrau
- Produkt-Maße: B x T x H, 350 x 530 x 523 mm
- Verpackungsmaße: B x T x H, 365 x 355 x 585 mm
- Gewicht mit Verpackung: 12 kg

- Separation: 2-fold
- Inner bins: 1 x 38 l, 1 x 7 l, Total capacity 45 l
- Type of installation: side-wall-mounted, self-adjusting to 16 - 19 mm side walls
- Slides: **covered, dampened slides with self-closing device with fully synchronized over-travel**
- System-depth 528 mm
- Sheet metal system Lid
- Colour: Metal parts silver-coloured, Plastic parts light-grey
- Product dimensions: W x D x H, 362-368 x 528 x 545 mm
- Packing dimensions: W x D x H, 490 x 320 x 620 mm
- Weight incl. packing 13,6 kg

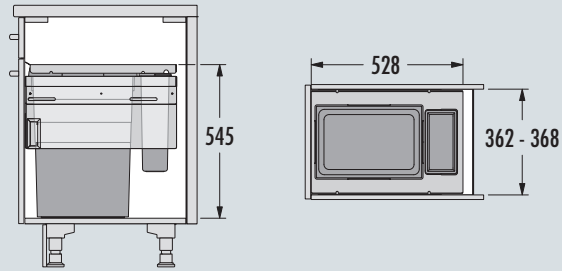

- Separation: 2-fold
- Inner bins: 2 x 24 l, Total capacity 48 l
2 x Lid 24 l
- Type of installation: bottom-mounted
- Slides: **dampened slides with self-closing device**
- System-depth 530 mm
- Colour: Frame sheet steel silver-coloured, Plastic parts light grey
- Product dimensions: W x D x H, 350 x 530 x 385 mm
- Packing dimensions: W x D x H, 365 x 355 x 585 mm
- Weight incl. packing: 9,9 kg

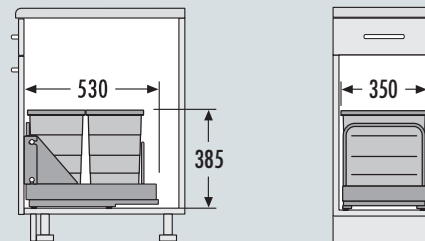

- Separation: 2-fold
- Inner bins: 2 x 29 l, Total capacity 58 l, 2 x Lid 29 l
- Type of installation: bottom-mounted
- Slides: **dampened slides with self-closing device**
- System-depth 530 mm
- Colour: Frame sheet steel silver-coloured, Plastic parts light grey
- Product dimensions: W x D x H, 350 x 530 x 523 mm
- Packing dimensions: W x D x H, 365 x 355 x 585 mm
- Weight incl. packing: 12 kg

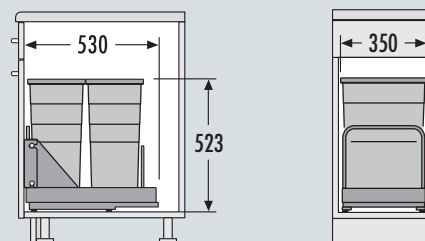



Übrigens, wussten Sie, ...

dass Hailo Einbau-Abfallsammler
ausnahmslos in Deutschland
hergestellt werden?

By the way, did you know...

that Hailo built-in waste
separation systems are exclusively
manufactured in Germany?

Swing



Für Schränke ab 450 mm Breite mit Drehtür
For hinged door cabinets from 450 mm width



45 cm

Swing



Für Schränke ab 450 mm Breite mit Drehtür
For hinged door cabinets from 450 mm width

Uno

Hailo AS Uno 18 weiß

3418001



- Abfalleimer: 1 x 18 l
- **Montageart:** Seitenwandmontage mit Türmitnehmer
- Automatischer Dreh-Kipp-Deckel
- Farbe: Metallteile weiß, Kunststoffteile weiß
- Produkt-Maße: B x T x H, 388 x 203 x 420 mm
- Verpackungsmaße: B x T x H, 395 x 206 x 405 mm
- Gewicht mit Verpackung: 3,1 kg
- Kann links- wie rechtsseitig montiert werden

Uno

Hailo AS Uno 18 Edelstahl/schwarz

3418101



- Abfalleimer: 1 x 18 l
- **Montageart:** Seitenwandmontage mit Türmitnehmer
- Automatischer Dreh-Kipp-Deckel
- Farbe: Metallteile Edelstahl, Kunststoffteile schwarz
- Produkt-Maße: B x T x H, 388 x 203 x 420 mm
- Verpackungsmaße: B x T x H, 395 x 206 x 405 mm
- Gewicht mit Verpackung: 3,1 kg
- Kann links- wie rechtsseitig montiert werden

Uno

Hailo AS Uno 18 Edelstahl/weiß

3418901



- Abfalleimer: 1 x 18 l
- **Montageart:** Seitenwandmontage mit Türmitnehmer
- Automatischer Dreh-Kipp-Deckel
- Farbe: Metallteile Edelstahl, Kunststoffteile weiß
- Produkt-Maße: B x T x H, 388 x 203 x 420 mm
- Verpackungsmaße: B x T x H, 395 x 206 x 405 mm
- Gewicht mit Verpackung: 3,1 kg
- Kann links- wie rechtsseitig montiert werden

Passend für Schränke 45 50 60 cm
Suitable for cabinets



- Inner bin: 1 x 18 l
- **Type of installation:** side-wall-mounted, with door follower
- Lid with turn & tilt mechanism
- Colour: Metal parts white, Plastic parts white
- Product dimensions: W x D x H, 388 x 203 x 420 mm
- Packing dimensions: W x D x H, 395 x 206 x 405 mm
- Weight incl. packing: 3,1 kg
- May be installed on left or on right sidewall

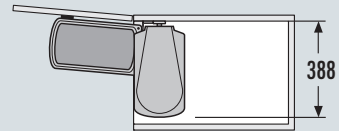
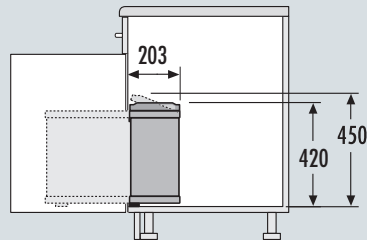

45 cm

Passend für Schränke 45 50 60 cm
Suitable for cabinets



- Inner bin: 1 x 18 l
- **Type of installation:** side-wall-mounted, with door follower
- Lid with turn & tilt mechanism
- Colour: Metal parts stainless steel, Plastic parts black
- Product dimensions: W x D x H, 388 x 203 x 420 mm
- Packing dimensions: W x D x H, 395 x 206 x 405 mm
- Weight incl. packing: 3,1 kg
- May be installed on left or on right sidewall

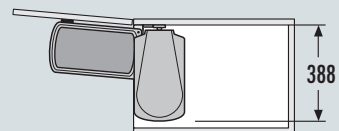
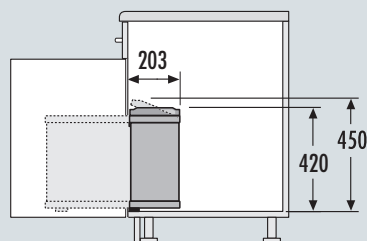

Passend für Schränke 45 50 60 cm
Suitable for cabinets



- Inner bin: 1 x 18 l
- **Type of installation:** side-wall-mounted, with door follower
- Lid with turn & tilt mechanism
- Colour: Metal parts stainless steel, Plastic parts white
- Product dimensions: W x D x H, 388 x 203 x 420 mm
- Packing dimensions: W x D x H, 395 x 206 x 405 mm
- Weight incl. packing: 3,1 kg
- May be installed on left or on right sidewall

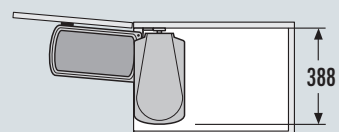
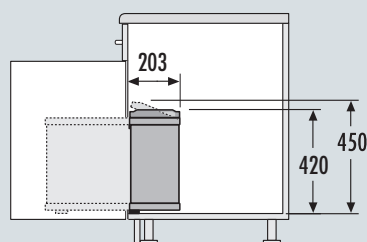

Swing



Für Schränke ab 450 mm Breite mit Drehtür
For hinged door cabinets from 450 mm width

Duo

Hailo AS Duo 8/8 weiß

3416001



- Trennung: 2-fach
- Abfalleimer: 2 x 8 l, Gesamtvolumen 16 l
- **Montageart: Seitenwandmontage** mit Türmitnehmer
- Automatischer Dreh-Kipp-Deckel
- Farbe: Metallteile weiß, Kunststoffteile weiß
- Produkt-Maße: B x T x H, 388 x 203 x 420 mm
- Verpackungsmaße: B x T x H, 395 x 206 x 405 mm
- Gewicht mit Verpackung: 4,2 kg
- Kann links- wie rechtsseitig montiert werden

Duo

Hailo AS Duo 8/8 Edelstahl/schwarz

3416101



- Trennung: 2-fach
- Abfalleimer: 2 x 8 l, Gesamtvolumen 16 l
- **Montageart: Seitenwandmontage** mit Türmitnehmer
- Automatischer Dreh-Kipp-Deckel
- Farbe: Metallteile Edelstahl, Kunststoffteile schwarz
- Produkt-Maße: B x T x H, 388 x 203 x 420 mm
- Verpackungsmaße: B x T x H, 395 x 206 x 405 mm
- Gewicht mit Verpackung: 4,2 kg
- Kann links- wie rechtsseitig montiert werden

Duo

Hailo AS Duo 8/8 Edelstahl/weiß

3416901



- Trennung: 2-fach
- Abfalleimer: 2 x 8 l, Gesamtvolumen 16 l
- **Montageart: Seitenwandmontage** mit Türmitnehmer
- Automatischer Dreh-Kipp-Deckel
- Farbe: Metallteile Edelstahl, Kunststoffteile weiß
- Produkt-Maße: B x T x H, 388 x 203 x 420 mm
- Verpackungsmaße: B x T x H, 395 x 206 x 405 mm
- Gewicht mit Verpackung: 4,2 kg
- Kann links- wie rechtsseitig montiert werden

Passend für Schränke 45 50 60 cm
Suitable for cabinets



- Separation: 2-fold
- Inner bins: 2 x 8 l, Total capacity 16 l
- **Type of installation:** side-wall-mounted, with door follower
- Lid with turn & tilt mechanism
- Colour: Metal parts white, Plastic parts white
- Product dimensions: W x D x H, 388 x 203 x 420 mm
- Packing dimensions: W x D x H, 395 x 206 x 405 mm
- Weight incl. packing: 4,2 kg
- May be installed on left or on right sidewall

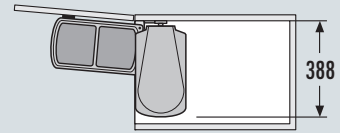
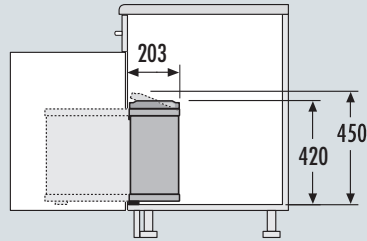

45 cm

Passend für Schränke 45 50 60 cm
Suitable for cabinets



- Separation: 2-fold
- Inner bins: 2 x 8 l, Total capacity 16 l
- **Type of installation:** side-wall-mounted, with door follower
- Lid with turn & tilt mechanism
- Colour: Metal parts stainless steel, Plastic parts black
- Product dimensions: W x D x H, 388 x 203 x 420 mm
- Packing dimensions: W x D x H, 395 x 206 x 405 mm
- Weight incl. packing: 4,2 kg
- May be installed on left or on right sidewall

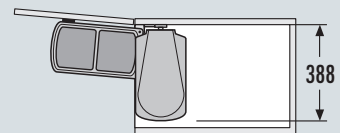
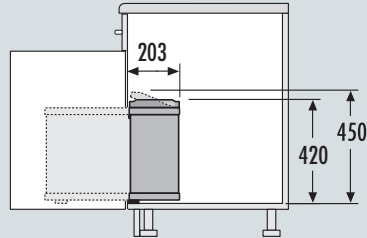

Passend für Schränke 45 50 60 cm
Suitable for cabinets



- Separation: 2-fold
- Inner bins: 2 x 8 l, Total capacity 16 l
- **Type of installation:** side-wall-mounted, with door follower
- Lid with turn & tilt mechanism
- Colour: Metal parts stainless steel, Plastic parts white
- Product dimensions: W x D x H, 388 x 203 x 420 mm
- Packing dimensions: W x D x H, 395 x 206 x 405 mm
- Weight incl. packing: 4,2 kg
- May be installed on left or on right sidewall

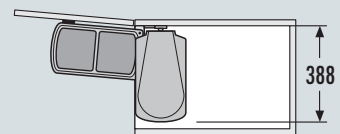
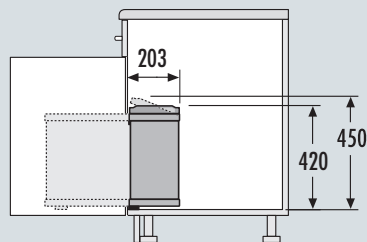



Übrigens, wussten Sie, ...

dass Hailo Einbautechnik Produkte mit über 100.000 Auszugszyklen getestet werden, bevor sie auf den Markt kommen?

By the way, did you know...

that Hailo Built-In Technology Products are tested on more than 100,000 pull-out cycles before they reach the market?

Slide



Für Schränke mit 450 mm Breite mit Frontauszug
For cabinets with front-mounted door of 450 mm width



45 cm

Slide



Für Schränke mit 450 mm Breite mit Frontauszug
For cabinets with front-mounted door of 450 mm width

Cargo Synchro

Hailo AS Cargo Synchro 450 18/18

3608471



- Trennung: 2-fach
- Abfalleimer: 2 x 18 l, Gesamtvolumen 36 l
- Montageart: Seitenwandmontage, selbstjustierend 16 - 19 mm
- **Auszugsschienen: abgedeckter, gedämpfter Selbsteinzug mit synchronisiertem Überauszug**
- Systemtiefe: 400 mm
- Herausfahrbarer Systemdeckel aus Metall/Kunststoff, vollflächig belegt mit rutschfester Gummimatte
- Farbe: Metall- und Kunststoffteile dunkelgrau
- Produkt-Maße: B x T x H, 412-418 x 400 x 424 mm
- Verpackungsmaße: B x T x H, 555 x 280 x 490 mm
- Gewicht mit Verpackung: 10,2 kg

Cargo Synchro

Hailo AS Cargo Synchro 450 55

3608461



- Abfalleimer: 1 x 55 l
- Montageart: Seitenwandmontage, selbstjustierend 16 - 19 mm
- **Auszugsschienen: abgedeckter, gedämpfter Selbsteinzug mit synchronisiertem Überauszug**
- Systemtiefe: 400 mm
- Herausfahrbarer Systemdeckel aus Metall/Kunststoff, vollflächig belegt mit rutschfester Gummimatte
- Farbe: Metall- und Kunststoffteile dunkelgrau
- Produkt-Maße: B x T x H, 412-418 x 400 x 544 mm
- Verpackungsmaße: B x T x H, 485 x 445 x 530 mm
- Gewicht mit Verpackung: 10,5 kg

Euro Cargo 45

Hailo AS Euro Cargo 450 38/38

3619731

NEW



- Trennung: 2-fach
- Abfalleimer: 2 x 38 l, Gesamtvolumen 76 l
- Montageart: Seitenwandmontage, selbstjustierend 16 - 19 mm
- **Auszugsschienen: abgedeckter, gedämpfter Selbsteinzug mit synchronisiertem Überauszug**
- Systemtiefe: 528 mm
- Metallsystemdeckel
- Farbe: Metall- und Kunststoffteile dunkelgrau
- Produkt-Maße: B x T x H, 412-418 x 528 x 545 mm
- Verpackungsmaße: B x T x H, 490 x 320 x 620 mm
- Gewicht mit Verpackung: 13 kg

- Separation: 2-fold
- Inner bins: 2 x 18 l, Total capacity 36 l
- Type of installation: side-wall-mounted, self-adjusting to 16 - 19 mm side walls
- **Slides: covered, dampened slides with self-closing device with fully synchronized over-travel**
- System-depth: 400 mm
- Pullout metal/plastic system lid, with anti-slip rubber mat
- Colour: Metal parts powder coated dark-grey, plastic parts dark-grey
- Product dimensions: W x D x H, 412-418 x 400 x 424 mm
- Packing dimensions: W x D x H, 555 x 280 x 490 mm
- Weight incl. packing: 10,2 kg

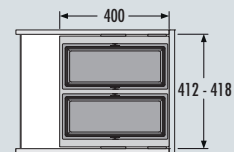
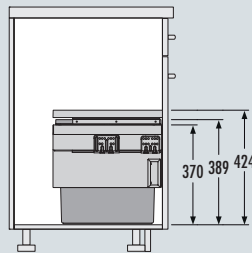

- Inner bin: 1 x 55 l
- Type of installation: side-wall-mounted, self-adjusting to 16 - 19 mm side walls
- **Slides: covered, dampened slides with self-closing device with fully synchronized over-travel**
- System-depth: 400 mm
- Pullout metal/plastic system lid, with anti-slip rubber mat
- Colour: Metal parts powder coated dark-grey, plastic parts dark-grey
- Product dimensions: W x D x H, 412-418 x 400 x 544 mm
- Packing dimensions: W x D x H, 485 x 445 x 530 mm
- Weight incl. packing: 10,5 kg

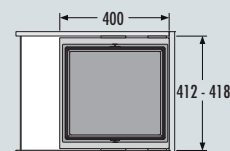
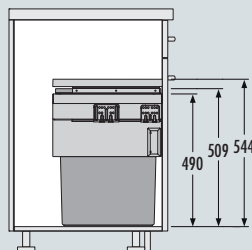

- Separation: 2-fold
- Inner bin: 2 x 38 l, Total capacity 76 l
- Type of installation: side-wall-mounted, self-adjusting to 16 - 19 mm side walls
- **Slides: covered, dampened slides with self-closing device with fully synchronized over-travel**
- System-depth: 528 mm
- Sheet metal system lid
- Colour: Metal parts powder coated dark-grey, plastic parts dark-grey
- Product dimensions: W x D x H, 412-418 x 528 x 545 mm
- Packing dimensions: W x D x H, 490 x 320 x 620 mm
- Weight incl. packing: 13 kg

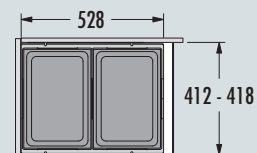
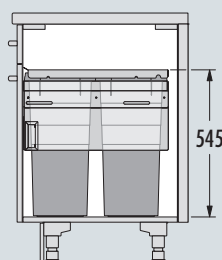



Für Schränke mit 450 mm Breite mit Frontauszug
For cabinets with front-mounted door of 450 mm width

Euro Cargo 45

Hailo AS Euro Cargo 450 38/38



3619471

NEW



- Trennung: 2-fach
- Abfalleimer: 2 x 38 l, Gesamtvolumen 76 l
- Montageart: Seitenwandmontage, selbstjustierend 16 - 19 mm
- **Auszugsschienen: abgedeckter, gedämpfter Selbsteinzug mit synchronisiertem Überauszug**
- Systemtiefe: 528 mm
- Metallsystemdeckel
- Farbe: Metallteile silberfarben, Kunststoffteile hellgrau
- Produkt-Maße: B x T x H, 412-418 x 528 x 545 mm
- Verpackungsmaße: B x T x H, 490 x 320 x 620 mm
- Gewicht mit Verpackung: 13 kg

Euro Cargo S

Hailo AS Euro Cargo S 450 19/19



3610471

- Trennung: 2-fach
- Abfalleimer: 2 x 19 l, Gesamtvolumen 38 l
- Montageart: Seitenwandmontage, selbstjustierend 16 - 19 mm
- **Auszugsschiene: abgedeckter, gedämpfter Selbsteinzug**
- Systemtiefe: 448 mm
- Metallsystemdeckel
- Farbe: Metallteile Stahlblech silberfarben
- Produkt-Maße: B x T x H, 412-418 x 403 x 439 mm
- Verpackungsmaße: B x T x H, 510 x 260 x 420 mm
- Gewicht mit Verpackung: 10,8 kg

Cargo

Hailo AS Cargo 450 21/17



3610811

NEW



- Trennung: 2-fach
- Abfalleimer: 1 x 21 l, 1 x 17 l, Gesamtvolumen 38 l
- Montageart: Seitenwandmontage, selbstjustierend 16 - 19 mm
- **Auszugsschienen: abgedeckter, gedämpfter Selbsteinzug mit synchronisiertem Überauszug**
- Systemtiefe: 448 mm
- Metallsystemdeckel
- Farbe: Metallteile & Kunststoffteile dunkelgrau
- Produkt-Maße: B x T x H, 412-418 x 434 x 370 mm

- Separation: 2-fold
- Inner bins: 2 x 38 l, Total capacity 76 l
- Type of installation: side-wall-mounted, self-adjusting to 16 - 19 mm side walls
- **Slides: covered, dampened slides with self-closing device with fully synchronized over-travel**
- System-depth 528 mm
- Sheet metal system Lid
- Colour: Metal parts silver-coloured, Plastic parts light-grey
- Product dimensions: W x D x H, 412-418 x 528 x 545 mm
- Packing dimensions: W x D x H, 490 x 320 x 620 mm
- Weight incl. packing: 13 kg

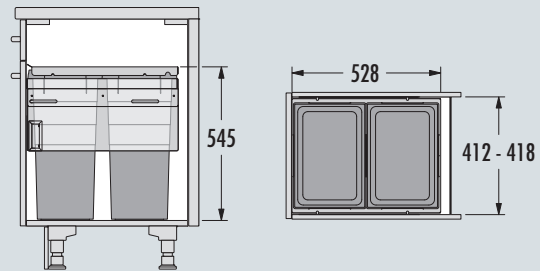

45 cm

- Separation: 2-fold
- Inner bins: 2 x 19 l, Total capacity 38 l
- Type of installation: side-wall-mounted, self-adjusting to 16 - 19 mm side walls
- **Slides: covered, dampened slides with self-closing device**
- System-depth: 448 mm
- Sheet metal system Lid
- Colour: Metal parts sheet steel silver-coloured
- Product dimensions: W x D x H, 412-418 x 403 x 439 mm
- Packing dimensions: W x D x H, 510 x 260 x 420 mm
- Weight incl. packing: 10,8 kg

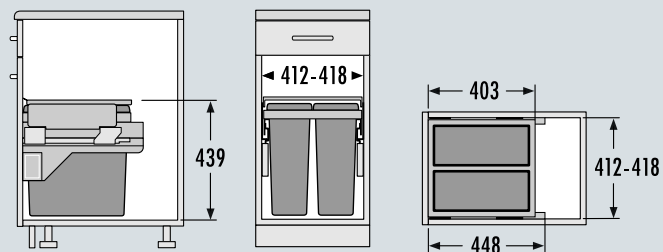

- Separation: 2-fold
- Inner bins: 1 x 21 l, 1 x 17 l, Total capacity 38 l
- Type of installation: side-wall-mounted, self-adjusting to 16 - 19 mm side walls
- **Slides: covered, dampened slides with self-closing device with fully synchronized over-travel**
- System-depth: 448 mm
- Sheet metal system Lid
- Colour: Metal parts powder coated dark-grey, plastic parts dark-grey
- Product dimensions: W x D x H, 412-418 x 334 x 370 mm

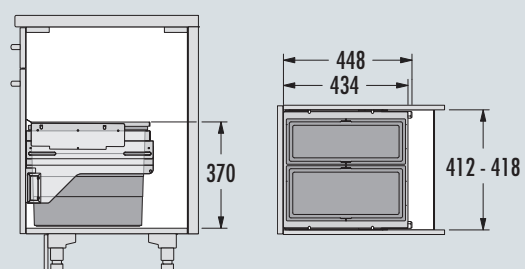

Slide



Für Schränke mit 450 mm Breite mit Frontauszug
For cabinets with front-mounted door of 450 mm width

Cargo Soft kurz
short

Hailo AS Cargo Soft short 450 14/14



- Trennung: 2-fach
- Abfalleimer: 2 x 14 l, Gesamtvolumen 28 l
- Montageart: Seitenwandmontage, selbstjustierend 16 - 19 mm
- **Auszugsschiene: abgedeckter, gedämpfter Selbstezug**
- Systemtiefe: 448 mm
- Metallsystemdeckel
- Farbe: Metallteile Stahlblech silberfarben
- Produkt-Maße: B x T x H, 412-418 x 332 x 370 mm
- Verpackungsmaße: B x T x H, 510 x 260 x 420 mm
- Gewicht mit Verpackung: 11 kg



- Separation: 2-fold
- Inner bins: 2 x 14 l, Total capacity 28 l
- Type of installation: side-wall-mounted, self-adjusting to 16 - 19 mm side walls, mounts also under sink
- Slides: covered, dampened slides with self-closing device
- System-depth: 448 mm
- Sheet metal system Lid
- Colour: Metal parts sheet steel silver-coloured
- Product dimensions: W x D x H, 412-418 x 332 x 370 mm
- Packing dimensions: W x D x H, 510 x 260 x 420 mm
- Weight incl. packing: 11 kg

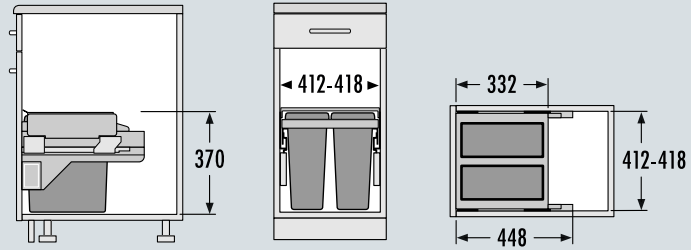

45 cm

Slide



Für Schränke mit 450 mm Breite mit Frontauszug
For cabinets with front-mounted door of 450 mm width

Hailo Kick and Go

Fußhebel

3691301



Fußhebel "Kick and go" für Frontauszüge und untere Schubkästen

Mehr Infos auf Seite 176

Hailo Libero 2.0

Elektronischer Türöffner

3697201



Hailo Libero – Hands Free Opener
Die Öffnungsunterstützung von Hailo für ein automatisches, komfortables Öffnen aller Abfalltrennsysteme mit Frontanbindung und aller Auszugssysteme.

Ausführliche Beschreibung Seite 172

Hailo Libero

Elektronischer Türöffner

3697101



Hailo Libero – Hands Free Opener
Die Öffnungsunterstützung von Hailo für ein automatisches, komfortables Öffnen aller Abfalltrennsysteme mit Frontanbindung und aller Auszugssysteme.

Ausführliche Beschreibung Seite 174

Kann in Verbindung mit Metalltüren, gerahmten Metalltüren und Metall-Sockeln zu Funktionsstörungen führen.

Foot Pedal

Foot Pedal "Kick and go" for Front mounted door and lower drawer

More information page 176

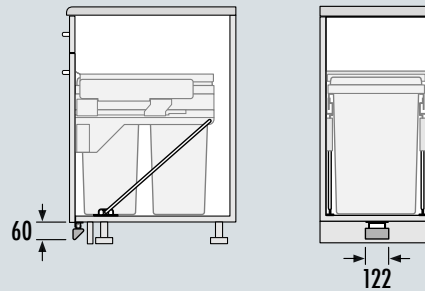

45 cm

Electronic Door Opener

Hailo „Libero“ – Hands Free Opener

Hailo's electronic front-mount-door and drawer-opener „Libero“ offers an automatic, comfortable hands-free opening of all waste-recycling-systems with attached door-panel and of any common, also damped, drawer-mounted systems.

More information: page 172

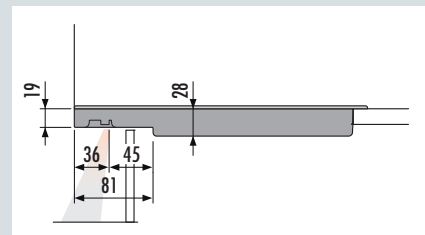
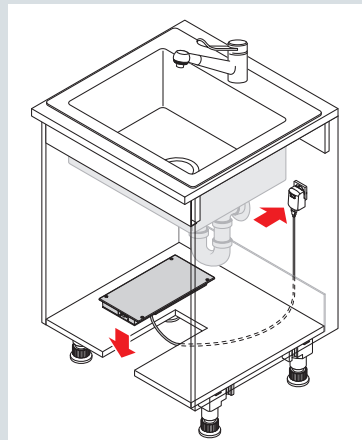

Electronic Door Opener

Hailo „Libero“ – Hands Free Opener

Hailo's electronic front-mount-door and drawer-opener „Libero“ offers an automatic, comfortable hands-free opening of all waste-recycling-systems with attached door-panel and of any common, also damped, drawer-mounted systems.

More information page 174

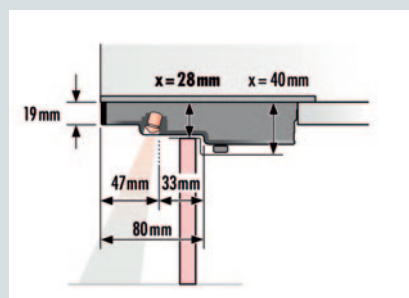

If installed behind a door-panel with a metal frame, or behind a metal cabinet-front, or above a metal plinth, malfunctions may occur.



Übrigens, wussten Sie, ...

dass Hailo im Verzeichnis „Marken des Jahrhunderts“ neben anderen 300 Premiummarken vertreten ist?

By the way, did you know...

that Hailo is amongst 300 premium brands listed in the “Brands of the Century” guide?

Inset



Einsatz für Schränke ab 450 mm Breite mit Frontauszug
For cabinets with pull-out shelf from 450 mm width



45 cm

Inset



Einsatz für Schränke mit 450 mm Breite mit Frontauszug
For cabinets with pull-out shelf from 450 mm width

Triple XL 45

Hailo AS Triple XL 450 55

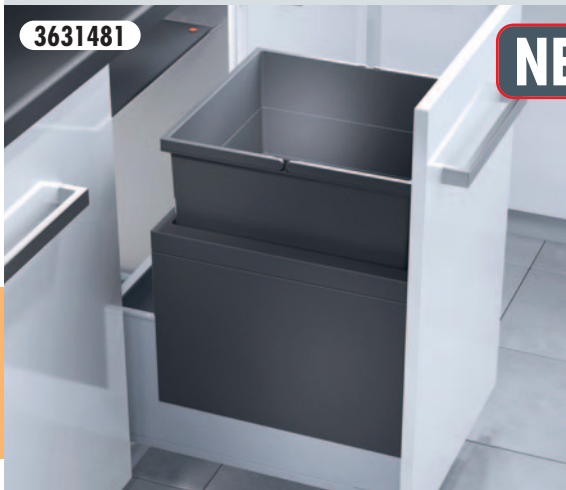

3631481

NEW



- Abfalleimer: 1 x 55 l
- **Montageart: Schubkastenmontage**, Seitenwandstärke 16 - 19 mm
- Schubkasten Nenntiefe \geq 420 mm
- Metall-Systemdeckel
- Farbe: Metall- und Kunststoffteile dunkelgrau
- Produkt-Maße: T x H, 400 x 522 mm
- Verpackungsmaße: B x T x H, 474 x 435 x 504 mm
- Gewicht mit Verpackung: 6,2 kg

Triple XL 45

Hailo AS Triple XL 450 18/18



3631491

NEW



- Trennung: 2-fach
- Abfalleimer: 2 x 18 l, Gesamtvolumen 36 l,
- **Montageart: Schubkastenmontage**, Seitenwandstärke 16 - 19 mm
- Schubkasten Nenntiefe \geq 420 mm
- Metall-Systemdeckel
- Farbe: Metall- und Kunststoffteile dunkelgrau
- Produkt-Maße: T x H, 400 x 402 mm
- Verpackungsmaße: B x T x H, 410 x 400 x 402 mm
- Gewicht mit Verpackung: 8,1 kg

XXL 45

Hailo AS XXL 450 18/D/12/P/U



3630451



- Trennung: 2-fach
- Abfalleimer: 1 x 18 l, 1 x 12 l, Gesamtvolumen 30 l,
1 x Putzmittelkorb 4,1 l, 1 x Behälterdeckel 18 l, 1 x Utensiliendepot
- **Montageart: Schubkastenmontage**, Seitenwandstärke 16 - 19 mm
- Schubkasten Nenntiefe \geq 450 mm
- Metall-Systemdeckel
- Farbe: Metallteile silberfarben
- Produkt-Maße: T x H, 433 x 330 mm
- Verpackungsmaße: B x T x H, 425 x 315 x 455 mm
- Gewicht mit Verpackung: 8,1 kg



4 007126 364333

- Inner bins: 1 x 55 l
- **Type of installation: inside available drawer,**
side-wall-thickness 16 - 19 mm
- Nominal drawer-depth \geq 420 mm
- Sheet metal system Lid
- Colour: Metal parts powder coated dark-grey,
plastic parts dark-grey
- Product dimensions: D x H, 400 x 522 mm
- Packing dimensions: W x D x H, 474 x 435 x 504 mm
- Weight incl. packing: 6,2 kg

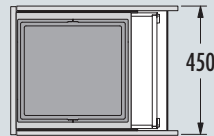
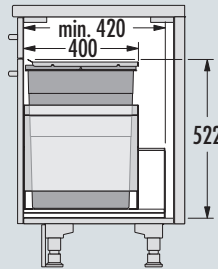

45 cm



4 007126 364340

- Separation: 2-fold
- Inner bins: 2 x 18 l, Total capacity 36 l
- **Type of installation: inside available drawer,**
side-wall-thickness 16 - 19 mm
- Nominal drawer-depth \geq 420 mm
- Sheet metal system Lid
- Colour: Metal parts powder coated dark-grey,
plastic parts dark-grey
- Product dimensions: D x H, 400 x 402 mm
- Packing dimensions: W x D x H, 410 x 400 x 402 mm
- Weight incl. packing: 8,1 kg

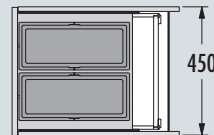
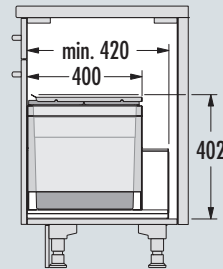

Niedrige Variante
Low Type



4 007126 304506

- Separation: 2-fold
- Inner bins: 1 x 18 l, 1 x 12 l, Total capacity 30 l
1 x Cleansers basket 4.1 l, 1 x Lid 18 l,
1 x utensil depot
- **Type of installation: inside available drawer,**
side-wall-thickness 16 - 19 mm
- Nominal drawer-depth \geq 450 mm
- Sheet metal system Lid
- Colour: Metal parts silver-coloured
- Product dimensions: D x H, 433 x 330 mm
- Packing dimensions: W x D x H, 425 x 315 x 455 mm
- Weight incl. packing: 8,1 kg

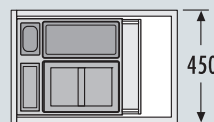
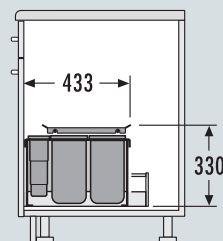

Inset



Einsatz für Schränke mit 450 mm Breite mit Frontauszug
For cabinets with pull-out shelf from 450 mm width

Separato K

Hailo AS Separato K 450 18/8/8/D



- Trennung: 3-fach
- Abfalleimer: 1 x 18 l, 2 x 8 l, Gesamtvolumen 34 l, 1 x Behälterdeckel 8 l
- **Montageart: Schubkastenmontage,** Seitenwandstärke 16 - 19 mm
- Schubkasten Nenntiefe \geq 500 mm
- Kunststoff-Deckel herausziehbar, Seitenwandmontage
- Farbe: Kunststoffteile hellgrau
- Produkt-Maße: B x T x H, 407 x 491 x 340 mm
- Verpackungsmaße: B x T x H, 510 x 420 x 285 mm
- Gewicht mit Verpackung: 3,7 kg
- Nicht für Blum Legra Box F

- Separation: 3-fold
- Inner bins: 1 x 18 l, 2 x 8 l, Total capacity 34 l
1 x Lid 8 l
- **Type of installation: inside available drawer,**
side-wall-thickness 16 - 19 mm
- Nominal drawer-depth ≥ 500 mm
- Plastic-lid single extension, sidewall-mounted
- Colour: Plastic parts light-grey
- Product dimensions: W x D x H, 407 x 491 x 340 mm
- Packing dimensions: W x D x H, 510 x 420 x 285 mm
- Weight incl. packing: 3,7 kg
- Not suitable for Blum Legra Box F

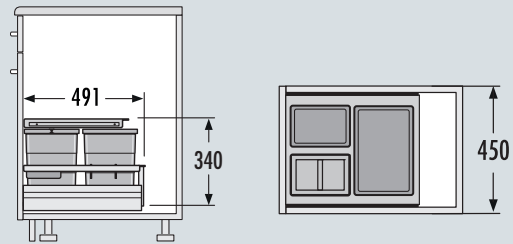

45 cm

Übrigens, wussten Sie, ...

dass Hailo Einbautechnik weltweit
in über 80 Länder exportiert?

By the way, did you know...

that Hailo Built-In Technology
exports to more than 80 countries
around the world?



Swing



Für Schränke ab 500 mm Breite mit Drehtür
For hinged door cabinets from 500 mm width



50 cm

Swing



Für Schränke ab 500 mm Breite mit Drehtür
For hinged door cabinets from 500 mm width

Easy Cargo

Hailo AS Easy Cargo 30/19

3668501



- Trennung: 2-fach
- Abfalleimer: 1 x 30 l, 1 x 19 l, Gesamtvolumen 49 l
- **Montageart: Bodenmontage**
- Auszugsschienen: Vollauszug
- Praktische Ablagemulde im Deckel integriert
- Farbe: Metallteile silberfarben, Kunststoffteile hellgrau
- Produkt-Maße: B x T x H, 430 x 465 x 455 mm
- Verpackungsmaße: B x T x H, 455 x 510 x 470 mm
- Gewicht mit Verpackung: 8,1 kg



Raumspär Tandem S

Hailo AS Raumspär Tandem S 18/12

3644701

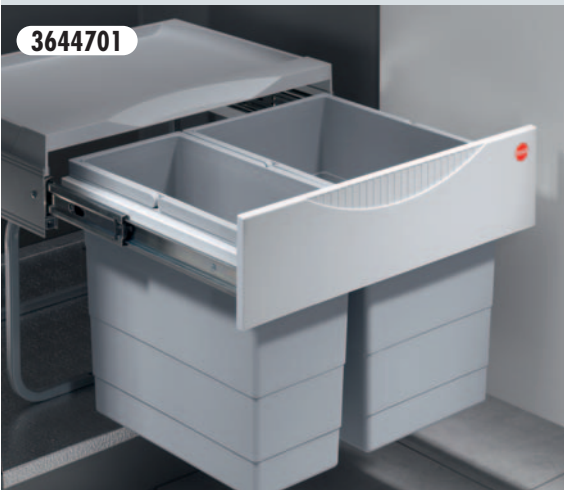

- Trennung: 2-fach
- Abfalleimer: 1 x 18 l, 1 x 12 l, Gesamtvolumen 30 l
- **Montageart: Bodenmontage**
- Auszugsschienen: Vollauszug
- Praktische Ablagemulde im Deckel integriert
- Farbe: Metallteile silberfarben, Kunststoffteile hellgrau
- Produkt-Maße: B x T x H, 434 x 330 x 347 mm
- Verpackungsmaße: B x T x H, 490 x 360 x 360 mm
- Gewicht mit Verpackung: 5 kg



Raumspär Tandem S

Hailo AS Raumspär Tandem S 12/8/8/D

3644731

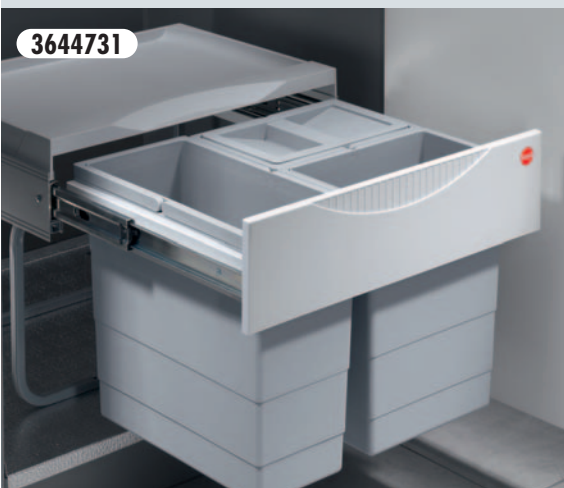

- Trennung: 3-fach
- Abfalleimer: 1 x 12 l, 2 x 8,5 l, Gesamtvolumen 29 l, 1 x Behälterdeckel 8,5 l
- **Montageart: Bodenmontage**
- Auszugsschienen: Vollauszug
- Praktische Ablagemulde im Deckel integriert
- Farbe: Metallteile silberfarben, Kunststoffteile hellgrau
- Produkt-Maße: B x T x H, 434 x 330 x 347 mm
- Verpackungsmaße: B x T x H, 490 x 360 x 360 mm
- Gewicht mit Verpackung: 5 kg



Passend für Schränke 50 60 cm
Suitable for cabinets



- Separation: 2-fold
- Inner bins: 1 x 30 l, 1 x 19 l, Total capacity 49 l
- **Type of installation: bottom-mounted**
- Slides: full extension
- Practical storage area integrated in the lid
- Colour: Metal parts silver-coloured, Plastic parts light grey
- Product dimensions: W x D x H, 430 x 465 x 455 mm
- Packing dimensions: W x D x H, 455 x 510 x 470 mm
- Weight incl. packing: 8,1 kg

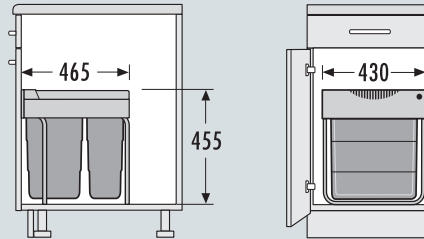

Passend für Schränke 50 60 cm
Suitable for cabinets



- Separation: 2-fold
- Inner bins: 1 x 18 l, 1 x 12 l, Total capacity 30 l
- **Type of installation: bottom-mounted**
- Slides: full extension
- Practical storage area integrated in the lid
- Colour: Metal parts silver-grey, Plastic parts light grey
- Product dimensions: W x D x H, 434 x 330 x 347 mm
- Packing dimensions: W x D x H, 490 x 360 x 360 mm
- Weight incl. packing: 5 kg

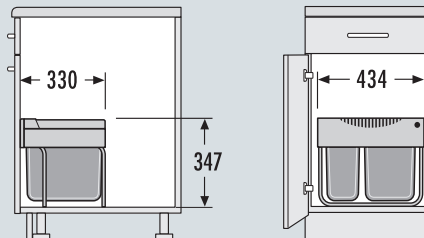

Passend für Schränke 50 60 cm
Suitable for cabinets



- Separation: 3-fold
- Inner bins: 1 x 12 l, 2 x 8.5 l, Total capacity 29 l
1 x Lid 8.5 l
- **Type of installation: bottom-mounted**
- Slides: full extension
- Practical storage area integrated in the lid
- Colour: Metal parts silver-coloured, Plastic parts light grey
- Product dimensions: W x D x H, 434 x 330 x 347 mm
- Packing dimensions: W x D x H, 490 x 360 x 360 mm
- Weight incl. packing: 5 kg

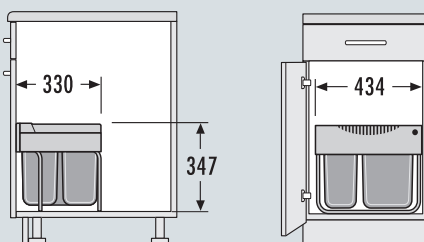



Übrigens, wussten Sie, ...

dass Hailo Einbautechnik Produkte mit über 100.000 Auszugszyklen getestet werden, bevor sie auf den Markt kommen?

By the way, did you know...

that Hailo Built-In Technology Products are tested on more than 100,000 pull-out cycles before they reach the market?

Slide



Für Schränke mit 500 mm Breite mit Frontauszug
For cabinets with front-mounted door of 500 mm width



50 cm

Slide



Für Schränke mit 500 mm Breite mit Frontauszug For front-mount-door cabinets of 500 mm width

Cargo Synchro

Hailo AS Cargo Synchro 500 28/18

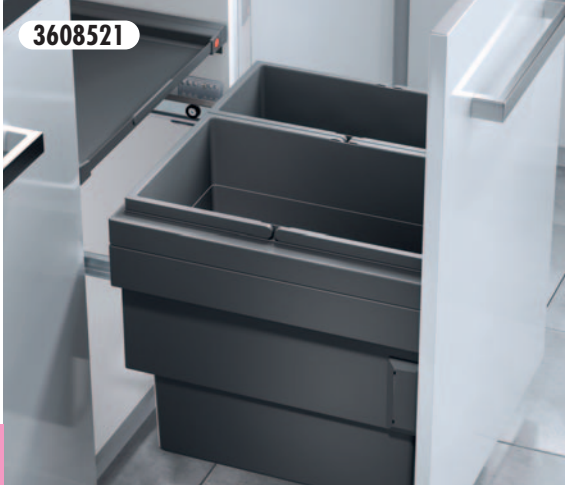

- Trennung: 2-fach
- Abfalleimer: 1 x 28 l, 1 x 18 l, Gesamtvolumen 46 l
- Montageart: Seitenwandmontage, selbstjustierend 16 - 19 mm
- **Auszugsschienen: abgedeckter, gedämpfter Selbsteinzug mit synchronisiertem Überauszug**
- Systemtiefe: 400 mm
- Herausfahrbarer Systemdeckel aus Metall/Kunststoff, vollflächig belegt mit rutschfester Gummimatte
- Farbe: Metall- und Kunststoffteile dunkelgrau
- Produkt-Maße: B x T x H, 462-468 x 400 x 424 mm
- Verpackungsmaße: B x T x H, 645 x 400 x 440 mm
- Gewicht mit Verpackung: 11,2 kg

Cargo Synchro

Hailo AS Cargo Synchro 500 18/13/13/D



- Trennung: 3-fach
- Abfalleimer: 1 x 18 l, 2 x 13 l, Gesamtvolumen 44 l, 1 x Behälterdeckel 13 l
- Montageart: Seitenwandmontage, selbstjustierend 16 - 19 mm
- **Auszugsschienen: abgedeckter, gedämpfter Selbsteinzug mit synchronisiertem Überauszug**
- Systemtiefe: 400 mm
- Herausfahrbarer Systemdeckel aus Metall/Kunststoff, vollflächig belegt mit rutschfester Gummimatte
- Farbe: Metall- und Kunststoffteile dunkelgrau
- Produkt-Maße: B x T x H, 462-468 x 400 x 424 mm
- Verpackungsmaße: B x T x H, 645 x 400 x 440 mm
- Gewicht mit Verpackung: 11,5 kg

Euro Cargo 50

Hailo AS Euro Cargo 500 38/38



- Trennung: 2-fach
- Abfalleimer: 2 x 38 l, Gesamtvolumen 76 l
- Montageart: Seitenwandmontage, selbstjustierend 16 - 19 mm, mit 4 x 25 mm Distanzstücken, auch für 50 cm Drehtür geeignet.
- **Auszugsschienen: abgedeckter, gedämpfter Selbsteinzug mit synchronisiertem Überauszug**
- Systemtiefe 528 mm
- Metallsystemdeckel
- Farbe: Metall- und Kunststoffteile dunkelgrau
- Produkt-Maße: B x T x H, 462-468 x 528 x 545 mm
- Verpackungsmaße: B x T x H, 490 x 320 x 620 mm
- Gewicht mit Verpackung: 13,3 kg

- Separation: 2-fold
- Inner bins: 1 x 28 l, 1 x 18 l, Total capacity 46 l
- Type of installation: side-wall-mounted, self-adjusting to 16 - 19 mm side walls
- Slides: covered, dampened slides with self-closing device with fully synchronized over-travel
- System-depth: 400 mm
- Pullout metal/plastic system lid, with anti-slip rubber mat
- Colour: Metal parts powder coated dark-grey, plastic parts dark-grey
- Product dimensions: W x D x H, 462-468 x 400 x 424 mm
- Packing dimensions: W x D x H, 645 x 400 x 440 mm
- Weight incl. packing: 11,2 kg

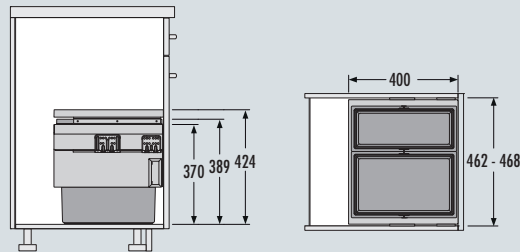

- Separation: 3-fold
- Inner bins: 1 x 18 l, 2 x 13 l, Total capacity 44 l, 1 x Lid 13 l
- Type of installation: side-wall-mounted, self-adjusting to 16 - 19 mm side walls
- Slides: covered, dampened slides with self-closing device with fully synchronized over-travel
- System-depth: 400 mm
- Pullout metal/ plastic system lid, with anti-slip rubber mat
- Colour: Metal parts powder coated dark-grey, plastic parts dark-grey
- Product dimensions: W x D x H, 462-468 x 400 x 424 mm
- Packing dimensions: W x D x H, 645 x 400 x 440 mm
- Weight incl. packing: 11,5 kg

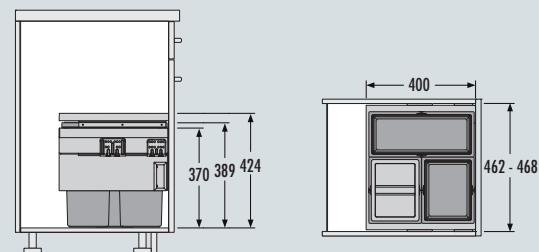

- Separation: 2-fold
- Inner bins: 2 x 38 l, Total capacity 76 l
- Type of installation: side-wall-mounted, self-adjusting to 16 - 19 mm side walls, with 4 x 25 mm spacer-blocks; also for 50 cm hinged door cabinet.
- Slides: covered, dampened slides with self-closing device with fully synchronized over-travel
- System-depth 528 mm
- Sheet metal system Lid
- Colour: Metal parts powder coated dark-grey, plastic parts dark-grey
- Product dimensions: W x D x H, 462 - 468 x 528 x 545 mm
- Packing dimensions: W x D x H, 490 x 320 x 620 mm
- Weight incl. packing: 13,3 kg

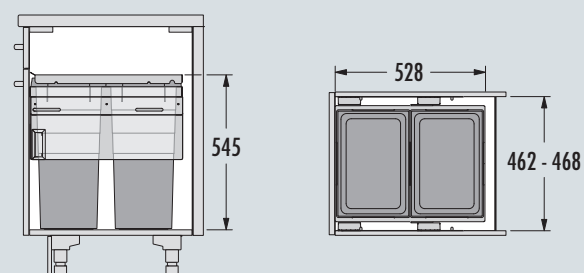

Slide



Für Schränke mit 500 mm Breite mit Frontauszug
For front-mount-door cabinets of 500 mm width

Euro Cargo 50



3619521

NEW



Hailo AS Euro Cargo 500 38/38

- Trennung: 2-fach
- Abfalleimer: 2 x 38 l, Gesamtvolumen 76 l
- Montageart: Seitenwandmontage, selbstjustierend 16 - 19 mm, mit 4 x 25 mm Distanzstücken, auch für 50 cm Drehtür geeignet.
- **Auszugsschienen: abgedeckter, gedämpfter Selbsteinzug mit synchronisiertem Überauszug**
- Systemtiefe 528 mm
- Metallsystemdeckel
- Farbe: Metallteile silberfarben, Kunststoffteile hellgrau
- Produkt-Maße: B x T x H, 462-468 x 528 x 545 mm
- Verpackungsmaße: B x T x H, 490 x 320 x 620 mm
- Gewicht mit Verpackung: 13,3 kg

Euro Cargo S



3610521



Hailo AS Euro Cargo S 500 30/19

- Trennung: 2-fach
- Abfalleimer: 1 x 30 l, 1 x 19 l, Gesamtvolumen 49 l
- Montageart: Seitenwandmontage, selbstjustierend 16 - 19 mm
- **Auszugsschienen: abgedeckter, gedämpfter Selbsteinzug**
- Systemtiefe: 448 mm
- Metallsystemdeckel
- Farbe: Metallteile Stahlblech silberfarben
- Produkt-Maße: B x T x H, 462-468 x 403 x 439 mm
- Verpackungsmaße: B x T x H, 395 x 415 x 510 mm
- Gewicht mit Verpackung: 11,1 kg

Cargo



3610821

NEW



Hailo AS Cargo 500 28/17

- Trennung: 2-fach
- Abfalleimer: 1 x 28 l, 1 x 17 l, Gesamtvolumen 45 l
- Montageart: Seitenwandmontage, selbstjustierend 16 - 19 mm
- **Auszugsschienen: abgedeckter, gedämpfter Selbsteinzug mit synchronisiertem Überauszug**
- Systemtiefe: 448 mm
- Metallsystemdeckel
- Farbe: Metallteile & Kunststoffteile dunkelgrau
- Produkt-Maße: B x T x H, 462-468 x 434 x 370 mm

- Separation: 2-fold
- Inner bins: 2 x 38 l, Total capacity 76 l
- Type of installation: side-wall-mounted, self-adjusting to 16 - 19 mm side walls, with 4 x 25 mm spacer-blocks; also for 50 cm hinged door cabinet.
- **Slides: covered, dampened slides with self-closing device with fully synchronized over-travel**
- System-depth 528 mm
- Sheet metal system Lid
- Colour: Metal parts silver-coloured, Plastic parts light-grey
- Product dimensions: W x D x H, 462- 468 x 528 x 545 mm
- Packing dimensions: W x D x H, 490 x 320 x 620 mm
- Weight incl. packing 13,3 kg

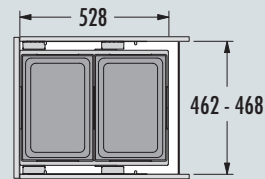
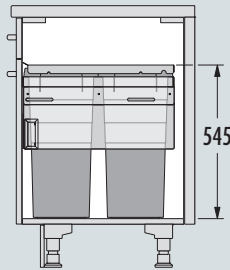

50 cm

- Separation: 2-fold
- Inner bins: 1 x 30 l, 1 x 19 l, Total capacity 49 l
- Type of installation: side-wall-mounted, self-adjusting to 16 - 19 mm side walls
- **Slides: covered, dampened slides with self-closing device**
- System-depth: 448 mm
- Sheet metal system Lid
- Colour: Metal parts sheet steel silver-coloured
- Product dimensions: W x D x H, 462- 468 x 403 x 439 mm
- Packing dimensions: W x D x H, 395 x 415 x 510 mm
- Weight incl. packing: 11,1 kg

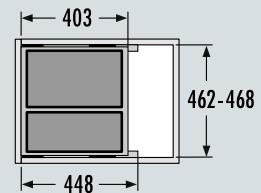
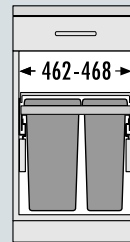
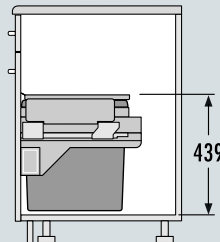

- Separation: 2-fold
- Inner bins: 1 x 28 l, 1 x 17 l, Total capacity 45 l
- Type of installation: side-wall-mounted, self-adjusting to 16 - 19 mm side walls
- **Slides: covered, dampened slides with self-closing device with fully synchronized over-travel**
- System-depth 448 mm
- Sheet metal system Lid
- Colour: Metal parts dark-grey, Plastic parts dark-grey
- Product dimensions: W x D x H, 462- 468 x 434 x 370 mm

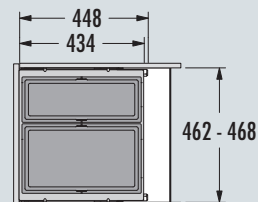
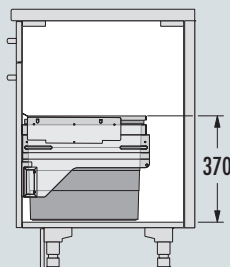

Slide



Für Schränke mit 500 mm Breite mit Frontauszug For front-mount-door cabinets of 500 mm width

Cargo

Hailo AS Cargo 500 17/13/13/D



NEW

3610831



- Trennung: 3-fach
- Abfalleimer: 1 x 17 l, 2 x 13 l, Gesamtvolumen 43 l, 1 Behälterdeckel 13 l
- Montageart: Seitenwandmontage, selbstjustierend 16 - 19 mm
- **Auszugsschienen: abgedeckter, gedämpfter Selbsteinzug mit synchronisiertem Überauszug**
- Systemtiefe: 448 mm
- Metallsystemdeckel
- Farbe: Metallteile & Kunststoffteile dunkelgrau
- Produkt-Maße: B x T x H, 462-468 x 434 x 370 mm

Cargo Soft kurz short

Hailo AS Cargo Soft short 500 20/14



3610581



- Trennung: 2-fach
- Abfalleimer: 1 x 20 l, 1 x 14 l, Gesamtvolumen 34 l
- Montageart: Seitenwandmontage, selbstjustierend 16 - 19 mm
- **Auszugsschienen: abgedeckter, gedämpfter Selbsteinzug**
- Systemtiefe: 448 mm
- Metallsystemdeckel
- Farbe: Metallteile Stahlblech silberfarben
- Produkt-Maße: B x T x H, 462-468 x 332 x 370 mm
- Verpackungsmaße: B x T x H, 510 x 345 x 415 mm
- Gewicht mit Verpackung: 10,7 kg

- Separation: 3-fold
- Inner bins: 1 x 17 l, 2 x 13 l, Total capacity 43 l, 1 x Lid 13 l
- Type of installation: side-wall-mounted, self-adjusting to 16 - 19 mm side walls
- Slides: covered, dampened slides with self-closing device with fully synchronized over-travel
- System-depth 448 mm
- Sheet metal system Lid
- Colour: Metal parts dark-grey, Plastic parts dark-grey
- Product dimensions: W x D x H, 462- 468 x 434 x 370 mm

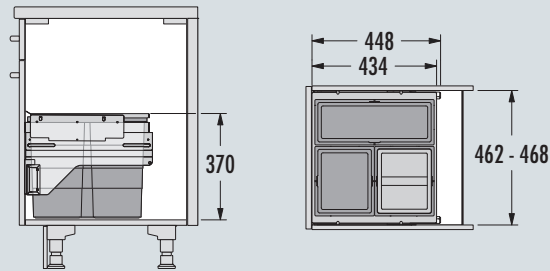

50 cm

- Separation: 2-fold
- Inner bins: 1 x 20 l, 1 x 14 l, Total capacity 34 l
- Type of installation: side-wall-mounted, self-adjusting to 16 - 19 mm side walls
- Slides: covered, dampened slides with self-closing device
- System-depth: 448 mm
- Sheet metal system Lid
- Colour: Metal parts sheet steel silver-coloured
- Product dimensions: W x D x H, 462- 468 x 332 x 370 mm
- Packing dimensions: W x D x H, 510 x 345 x 415 mm
- Weight incl. packing: 10,7 kg

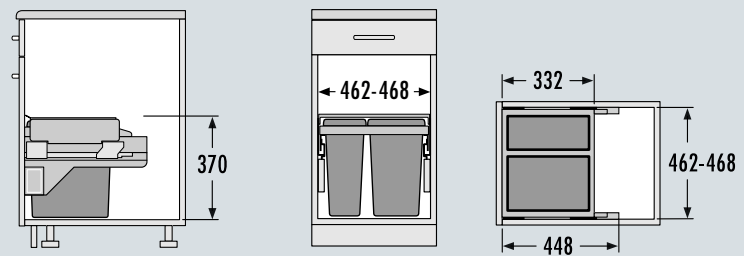

Slide



Für Schränke mit 500 mm Breite mit Frontauszug
For front-mount-door cabinets of 500 mm width

Hailo Kick and Go

Fußhebel

3691301



Fußhebel "Kick and go" für Frontauszüge
und untere Schubkästen

Mehr Infos auf Seite 176

Hailo Libero 2.0

Elektronischer Türöffner

3697201



Hailo Libero – Hands Free Opener
Die Öffnungsunterstützung von Hailo für ein auto-
matisches, komfortables Öffnen aller Abfalltrenn-
systeme mit Frontanbindung und aller Auszugssysteme.

Ausführliche Beschreibung Seite 172

Hailo Libero

Elektronischer Türöffner

3697101



Hailo Libero – Hands Free Opener
Die Öffnungsunterstützung von Hailo für ein auto-
matisches, komfortables Öffnen aller Abfalltrenn-
systeme mit Frontanbindung und aller Auszugssysteme.

Ausführliche Beschreibung Seite 174

Kann in Verbindung mit Metalltüren,
gerahmten Metalltüren und Metall-Sockeln
zu Funktionsstörungen führen.

Foot Pedal

Foot Pedal "Kick and go" for Front mounted door and lower drawer

More information page 176

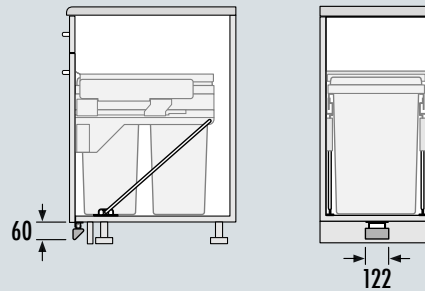

50 cm

Electronic Door Opener

Hailo „Libero“ – Hands Free Opener

Hailo's electronic front-mount-door and drawer-opener „Libero“ offers an automatic, comfortable hands-free opening of all waste-recycling-systems with attached door-panel and of any common, also damped, drawer-mounted systems.

More information: page 172

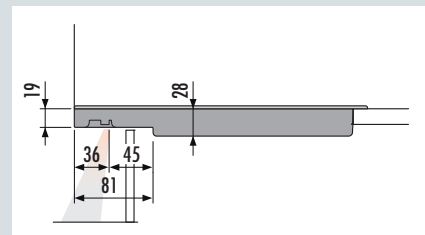
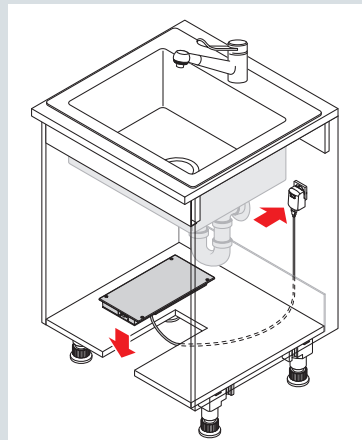

Electronic Door Opener

Hailo „Libero“ – Hands Free Opener

Hailo's electronic front-mount-door and drawer-opener „Libero“ offers an automatic, comfortable hands-free opening of all waste-recycling-systems with attached door-panel and of any common, also damped, drawer-mounted systems.

More information page 174

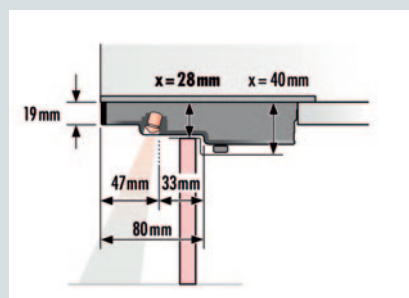

If installed behind a door-panel with a metal frame, or behind a metal cabinet-front, or above a metal plinth, malfunctions may occur.



Übrigens, wussten Sie, ...

dass Hailo die größte Eimervielfalt für jeden Bedarf vorhält?

By the way, did you know...

that Hailo provides the widest range of bins for all requirements?

Inset



Einsatz für Schränke ab 500 mm Breite mit Frontauszug
For cabinets with pull-out shelf from 500 mm width



50 cm

Inset



Einsatz für Schränke ab 500 mm Breite mit Frontauszug
For cabinets with pull-out drawer, from 500 mm width

Triple XL 50

Hailo AS Triple XL 500 18/28

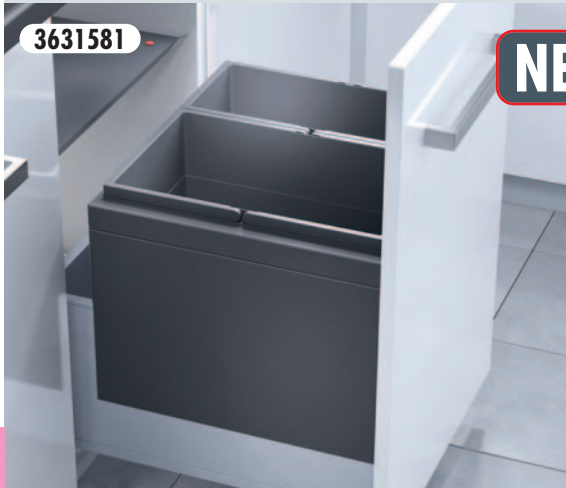

3631581

NEW



- Trennung: 2-fach
- Abfalleimer: 1 x 28 l, 1 x 18 l, Gesamtvolumen 46 l
- **Montageart: Schubkastenmontage**, Seitenwandstärke 16 - 19 mm
- Schubkasten Nenntiefe \geq 420 mm
- Metall-Systemdeckel
- Farbe: Metall- und Kunststoffteile dunkelgrau
- Produkt-Maße: T x H, 400 x 402 mm
- Verpackungsmaße: B x T x H, 460 x 400 x 402 mm
- Gewicht mit Verpackung: 8,4 kg

Triple XL 50

Hailo AS Triple XL 500 18/13/13/D



3631591

NEW



- Trennung: 3-fach
- Abfalleimer: 1 x 18 l, 2 x 13 l, Gesamtvolumen 44 l
1 x Behälterdeckel 13 l
- **Montageart: Schubkastenmontage**
Seitenwandstärke 16 bis 19 mm
- Schubkasten Nenntiefe \geq 420 mm
- Metallsystemdeckel
- Farbe: Metall- und Kunststoffteile dunkelgrau
- Produkt-Maße: T x H, 400 x 402 mm
- Verpackungsmaße: B x T x H, 460 x 400 x 402 mm
- Gewicht mit Verpackung: 9,2 kg

XXL 50

Hailo AS XXL 500 12/8,5/8,5/D/P/P



3630501



- Trennung: 3-fach
- Abfalleimer: 1 x 12 l, 2 x 8,5 l, Gesamtvolumen 29 l,
2 x Putzmittelkorb 4,1 l, 1 x Behälterdeckel 12 l
- **Montageart: Schubkastenmontage**,
Seitenwandstärke 16 bis 19 mm
- Schubkasten Nenntiefe \geq 450 mm
- Metallsystemdeckel
- Farbe: Metallteile silberfarben
- Produkt-Maße: T x H, 433 x 330 mm
- Verpackungsmaße: B x T x H, 455 x 315 x 475 mm
- Gewicht mit Verpackung: 8,5 kg



- Separation: 2-fold
- Inner bins: 1 x 28 l, 1 x 18 l, Total capacity 46 l
- **Type of installation: inside available drawer,**
side-wall-thickness 16 - 19 mm
- Nominal drawer-depth \geq 420 mm
- Sheet metal system Lid
- Colour: Metal parts powder coated dark-grey,
plastic parts dark-grey
- Product dimensions: D x H, 400 x 402 mm
- Packing dimensions: W x D x H, 460 x 400 x 402 mm
- Weight incl. packing: 8,4 kg

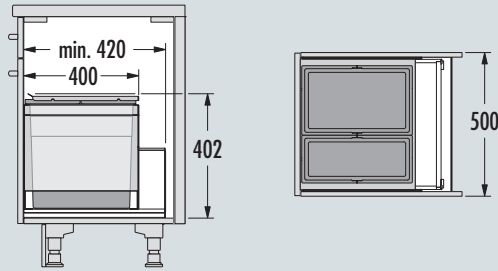

- Separation: 3-fold
- Inner bins: 1 x 18 l, 2 x 13 l, Total capacity 44 l
1 x Lid 13 l
- **Type of installation: inside available drawer,**
side-wall-thickness 16 - 19 mm
- Nominal drawer-depth \geq 420 mm
- Sheet metal system Lid
- Colour: Metal parts powder coated dark-grey,
plastic parts dark-grey
- Product dimensions: D x H, 400 x 402 mm
- Packing dimensions: W x D x H, 460 x 400 x 402 mm
- Weight incl. packing: 9,2 kg

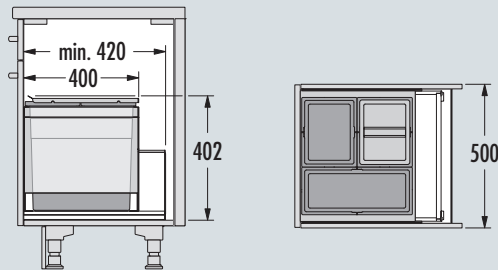

Niedrige Variante
Low Type



- Separation: 3-fold
- Inner bins: 1 x 12 l, 2 x 8.5 l, Total capacity 29 l
2 x Cleaners basket 4.1 l, 1 x Lid 12 l
- **Type of installation: inside available drawer,**
side-wall-thickness 16 - 19 mm
- Nominal drawer-depth \geq 450 mm
- Sheet metal system Lid
- Colour: Metal parts silver-coloured
- Product dimensions: D x H, 433 x 330 mm
- Packing dimensions: W x D x H, 455 x 315 x 475 mm
- Weight incl. packing: 8,5 kg

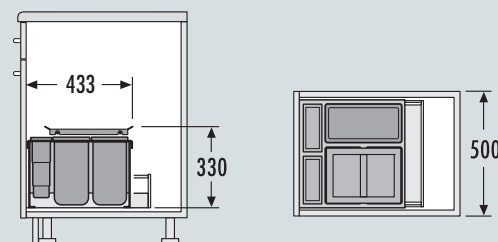

Inset



Einsatz für Schränke ab 500 mm Breite mit Frontauszug
For cabinets with pull-out drawer, from 500 mm width

Separato K

Hailo AS Separato K 500 18/8/8/D



- Trennung: 3-fach
- Abfalleimer: 1 x 18 l, 2 x 8 l, Gesamtvolumen 34 l, 1 x Behälterdeckel 8 l
- **Montageart: Schubkastenmontage,** Seitenwandstärke 16 bis 19 mm
- Schubkasten Nenntiefe \geq 500 mm
- Kunststoff-Deckel herausziehbar, Seitenwandmontage
- Farbe: Kunststoffteile hellgrau
- Produkt-Maße: B x T x H, 457 x 491 x 340 mm
- Verpackungsmaße: B x T x H, 510 x 470 x 285 mm
- Gewicht mit Verpackung: 4,1 kg
- Nicht für Blum Legra Box F



- Separation: 3-fold
- Inner bins: 1 x 18 l, 2 x 8 l Total capacity 34 l
1 x Lid 8 l
- **Type of installation: inside available drawer,**
side-wall-thickness 16 - 19 mm
- Nominal drawer-depth ≥ 500 mm
- Plastic-lid single extension, sidewall-mounted
- Colour: Plastic parts light-grey
- Product dimensions: W x D x H, 457 x 491 x 340 mm
- Packing dimensions: W x D x H, 510 x 470 x 285 mm
- Weight incl. packing: 4,1kg
- Not suitable for Blum Legra Box F

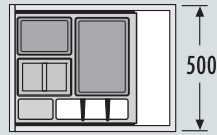
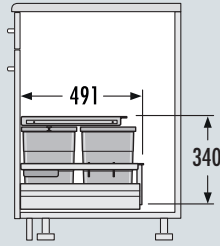

50 cm



Übrigens, wussten Sie, ... dass Hailo bereits in der
Gründungszeit 1947 Abfallsammler
produzierte?

By the way, did you know... that Hailo has been producing
waste bins right from the outset,
early 1947?

Swing



Für Schränke ab 600 mm Breite mit Drehtür
For hinged door cabinets from 600 mm width



60 cm

Swing



Für Schränke ab 600 mm Breite mit Drehtür
For hinged door cabinets from 600 mm width

Raumspär Tandem S plus

Hailo AS Raumspär Tandem S plus 18/12

3644801



- Trennung: 2-fach
- Abfalleimer: 1 x 18 l, 1 x 12 l, Gesamtvolumen 30 l
- **Montageart: Bodenmontage**
- Auszugsschienen: Vollauszug mit Ausfahrautomatik
- Metallsystemdeckel, Seitenwandmontage
- Farbe: Metallteile silberfarben, Kunststoffteile hellgrau
- Produkt-Maße: B x T x H, 556 x 367 x 376 mm
- Verpackungsmaße: B x T x H, 580 x 400 x 360 mm
- Gewicht mit Verpackung: 8,5 kg

Raumspär Tandem S plus

Hailo AS Raumspär Tandem S plus 12/8/8/D

3644831



- Trennung: 3-fach
- Abfalleimer: 1 x 12 l, 2 x 8,5 l, Gesamtvolumen 29 l, 1 x Behälterdeckel 8,5 l
- **Montageart: Bodenmontage**
- Auszugsschienen: Vollauszug mit Ausfahrautomatik
- Metallsystemdeckel, Seitenwandmontage
- Farbe: Metallteile silberfarben, Kunststoffteile hellgrau
- Produkt-Maße: B x T x H, 556 x 367 x 376 mm
- Verpackungsmaße: B x T x H, 580 x 400 x 360 mm
- Gewicht mit Verpackung: 8,1 kg

Raumspär Tandem S plus

Hailo AS Raumspär Tandem S plus 18/12

3644821



- Trennung: 2-fach
- Abfalleimer: 1 x 18 l, 1 x 12 l, Gesamtvolumen 30 l
- **Montageart: Bodenmontage**
- Auszugsschienen: Vollauszug mit Ausfahrautomatik
- Praktische Ablagemulde im Kunststoff-Deckel integriert (Seitenwandunabhängig)
- Farbe: Metallteile silberfarben, Kunststoffteile hellgrau
- Produkt-Maße: B x T x H, 432 x 338 x 360 mm
- Verpackungsmaße: B x T x H, 490 x 360 x 360 mm
- Gewicht mit Verpackung: 8,5 kg



- Separation: 2-fold
- Inner bins: 1 x 18 l, 1 x 12 l, Total capacity 30 l
- **Type of installation: bottom-mounted**
- Slides: full extension with automatic door-follower
- Sheet metal system Lid, sidewall-mounted
- Colour: Metal parts silver-coloured, Plastic parts light grey
- Product dimensions: W x D x H, 556 x 367 x 376 mm
- Packing dimensions: W x D x H, 580 x 400 x 360 mm
- Weight incl. packing: 8,5 kg

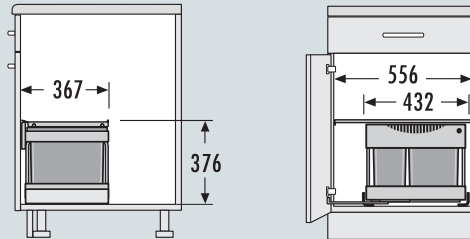

- Separation: 3-fold
- Inner bins: 1 x 12 l, 2 x 8.5 l, Total capacity 29 l, 1x Lid 8.5 l
- **Type of installation: bottom-mounted, in single-door-cabinet**
- Slides: full extension with automatic door-follower
- Sheet metal system Lid, sidewall-mounted
- Colour: Metal parts silver-coloured, Plastic parts light grey
- Product dimensions: W x D x H, 556 x 367 x 376 mm
- Packing dimensions: W x D x H, 580 x 400 x 360 mm
- Weight incl. packing: 8,1 kg

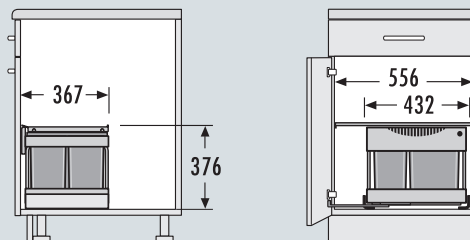

- Separation: 2-fold
- Inner bins: 1 x 18 l, 1 x 12 l, Total capacity 30 l
- **Type of installation: bottom-mounted**
- Slides: full extension with automatic door-follower
- Practical storage area integrated in the plastic-lid (fixed on frame, independent of sidewall)
- Colour: Metal parts silver-coloured, Plastic parts light-grey
- Product dimensions: W x D x H, 432 x 338 x 360 mm
- Packing dimensions: W x D x H, 490 x 360 x 360 mm
- Weight incl. packing: 8,5 kg

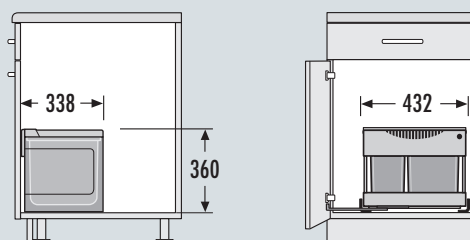

Übrigens, wussten Sie, ...

By the way, did you know...

... dass Hailo für die meisten Produkte eine Montageanleitung auf der Website zur Verfügung stellt?

... that Hailo installation instructions for most products are available on the website?

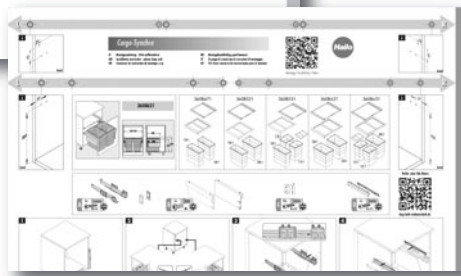

Slide



Für Schränke mit 600 mm Breite mit Frontauszug
For cabinets with front-mount-door of 600 mm width



60 cm

Slide



Für Schränke mit 600 mm Breite mit Frontauszug For cabinets with front-mount-door of 600 mm width

Cargo Synchro



3608621



Hailo AS Cargo Synchro 600 28/28

- Trennung: 2-fach
- Abfalleimer: 2 x 28 l, Gesamtvolumen 56 l
- Montageart: Seitenwandmontage, selbstjustierend 16 - 19 mm
- **Auszugsschienen: abgedeckter, gedämpfter Selbstezug mit synchronisiertem Überauszug**
- Systemtiefe: 400 mm
- Herausfahbarer Metallsystemdeckel/Kunststoff, vollflächig belegt mit rutschfester Gummimatte
- Farbe: Metall- und Kunststoffteile dunkelgrau
- Produkt-Maße: B x T x H, 562-568 x 400 x 424 mm
- Verpackungsmaße: B x T x H, 575 x 340 x 480 mm
- Gewicht mit Verpackung: 11,8 kg

Cargo Synchro



3608631



Hailo AS Cargo Synchro 600 28/13/13/D

- Trennung: 3-fach
- Abfalleimer: 1 x 28 l, 2 x 13 l, Gesamtvolumen 54 l, 1 x Behälterdeckel 13 l
- Montageart: Seitenwandmontage, selbstjustierend 16 - 19 mm
- **Auszugsschienen: abgedeckter, gedämpfter Selbstezug mit synchronisiertem Überauszug**
- Systemtiefe: 400 mm
- Herausfahbarer Metallsystemdeckel/Kunststoff, vollflächig belegt mit rutschfester Gummimatte
- Farbe: Metall- und Kunststoffteile dunkelgrau
- Produkt-Maße: B x T x H, 562-568 x 400 x 424 mm
- Verpackungsmaße: B x T x H, 575 x 340 x 480 mm
- Gewicht mit Verpackung: 12,1 kg

Euro Cargo 60



3619771

NEW



Hailo AS Euro Cargo 600 38/38/12/D/2,5

- Trennung: 4-fach
- Abfalleimer: 2 x 38 l, 1 x 12 l, 1 x 2,5 l, Gesamtvolumen 91 l, 1 x Behälterdeckel 12 l
- Montageart: Seitenwandmontage, selbstjustierend 16 - 19 mm
- **Auszugsschienen: abgedeckter, gedämpfter Selbstezug mit synchronisiertem Überauszug**
- Systemtiefe 528 mm
- Metallsystemdeckel
- Farbe: Metall- und Kunststoffteile dunkelgrau
- Produkt-Maße: B x T x H, 562-568 x 528 x 545 mm
- Verpackungsmaße: B x T x H, 590 x 325 x 620 mm
- Gewicht mit Verpackung: 15,5 kg

- Separation: 2-fold
- Inner bins: 2 x 28 l, Total capacity 56 l
- Type of installation: side-wall-mounted, self-adjusting to 16 - 19 mm side walls
- **Slides: covered, dampened slides with self-closing device with fully synchronized over-travel**
- System-depth: 400 mm
- Pullout metal/plastic system lid, with anti-slip rubber mat
- Colour: Metal parts powder coated dark-grey, plastic parts dark-grey
- Product dimensions: W x D x H, 562-568 x 400 x 424 mm
- Packing dimensions: W x D x H, 575 x 340 x 480 mm
- Weight incl. packing: 11,8 kg

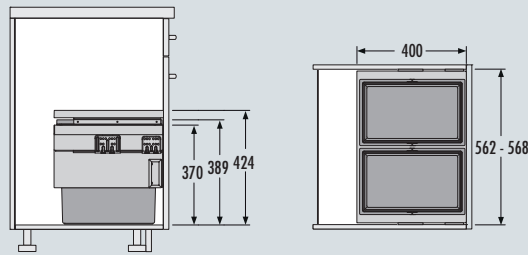

- Separation: 3-fold
- Inner bins: 1 x 28 l, 2 x 13 l, Total capacity 54 l
1 x Lid 13 l
- Type of installation: side-wall-mounted, self-adjusting to 16 - 19 mm side walls
- **Slides: covered, dampened slides with self-closing device with fully synchronized over-travel**
- System-depth: 400 mm
- Pullout metal/ plastic system lid, with anti-slip rubber mat
- Colour: Metal parts powder coated dark-grey, plastic parts dark-grey
- Product dimensions: W x D x H, 562-568 x 400 x 424 mm
- Packing dimensions: W x D x H, 575 x 340 x 480 mm
- Weight incl. packing: 12,1 kg

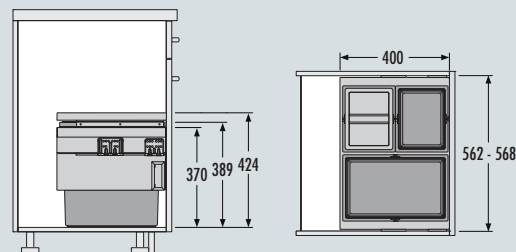

- Separation: 4-fold
- Inner bins: 2 x 38 l, 1 x 12 l, 1 x 2.5 l,
Total capacity 91 l, 1 x Lid 12 l
- Type of installation: side-wall-mounted, self-adjusting to 16 - 19 mm side walls
- **Slides: covered, dampened slides with self-closing device with fully synchronized over-travel**
- System-depth 528 mm
- Sheet metal system Lid
- Colour: Metal & plastic parts powder coated dark-grey
- Product dimensions: W x D x H, 562-568 x 528 x 545 mm
- Packing dimensions: W x D x H, 590 x 325 x 620 mm
- Weight incl. packing: 15,5 kg

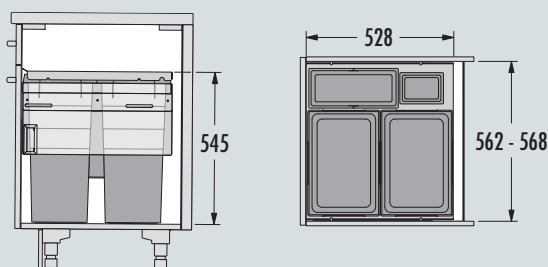

Slide



Für Schränke mit 600 mm Breite mit Frontauszug
For cabinets with front-mount-door of 600 mm width

Euro Cargo 60

Hailo AS Euro Cargo 600 38/38/12/D/2,5

3619621

NEW



- Trennung: 4-fach
- Abfalleimer: 2 x 38 l, 1 x 12 l, 1 x 2,5 l, Gesamtvolumen 91 l, 1 x Behälterdeckel 12 l
- Montageart: Seitenwandmontage, selbstjustierend 16 - 19 mm
- Auszugsschienen: **abgedeckter, gedämpfter Selbsteinzug mit synchronisiertem Überauszug**
- Systemtiefe 528 mm
- Metallsystemdeckel
- Farbe: Metallteile silberfarben, Kunststoffteile hellgrau
- Produkt-Maße: B x T x H, 562-568 x 528 x 545 mm
- Verpackungsmaße: B x T x H, 590 x 325 x 620 mm
- Gewicht mit Verpackung: 15,5 kg

Cargo

Hailo AS Cargo 600 28/28

3610841

NEW



- Trennung: 2-fach
- Abfalleimer: 2 x 28 l, Gesamtvolumen 56 l
- Montageart: Seitenwandmontage, selbstjustierend 16 - 19 mm
- Auszugsschienen: **abgedeckter, gedämpfter Selbsteinzug mit synchronisiertem Überauszug**
- Systemtiefe: 448 mm
- Metallsystemdeckel
- Farbe: Metallteile & Kunststoffteile dunkelgrau
- Produkt-Maße: B x T x H, 562-568 x 434 x 370 mm

Cargo

Hailo AS Cargo 600 28/13/13/D

3610851

NEW



- Trennung: 3-fach
- Abfalleimer: 1 x 28 l, 2 x 13 l, Gesamtvolumen 54 l, 1 Behälterdeckel 13 l
- Montageart: Seitenwandmontage, selbstjustierend 16 - 19 mm
- Auszugsschienen: **abgedeckter, gedämpfter Selbsteinzug mit synchronisiertem Überauszug**
- Systemtiefe: 448 mm
- Metallsystemdeckel
- Farbe: Metallteile & Kunststoffteile dunkelgrau
- Produkt-Maße: B x T x H, 562-568 x 434 x 370 mm

- Separation: 4-fold
- Inner bins: 2 x 38 l, 1 x 12 l, 1 x 2.5 l, Total capacity 91 l, 1 x Lid 12 l
- Type of installation: side-wall-mounted, self-adjusting to 16 - 19 mm side walls
- Slides: covered, dampened slides with self-closing device with fully synchronized over-travel
- System-depth 528 mm
- Sheet metal system Lid
- Colour: Metal parts silver-coloured, Plastic parts light-grey
- Product dimensions: W x D x H, 562-568 x 528 x 545 mm
- Packing dimensions: W x D x H, 590 x 325 x 620 mm
- Weight incl. packing 15,5 kg

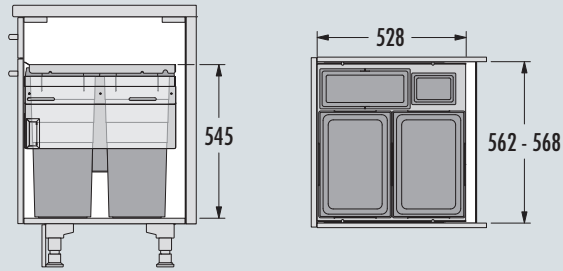

- Separation: 2-fold
- Inner bins: 2 x 28 l, Total capacity 56 l
- Type of installation: side-wall-mounted, self-adjusting to 16 - 19 mm side walls
- Slides: covered, dampened slides with self-closing device with fully synchronized over-travel
- System-depth: 448 mm
- Sheet metal system Lid
- Colour: Metall & Plastic parts dark-grey
- Product Dimensions: B x T x H, 562-568 x 434 x 370 mm

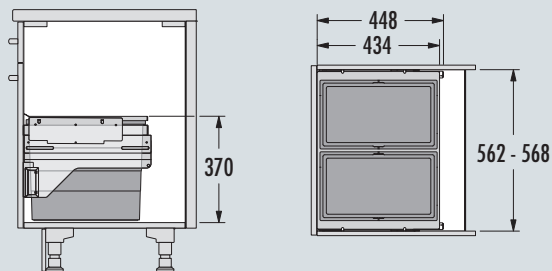

- Separation: 3-fold
- Inner bins: 1 x 28 l, 2 x 13 l, Total capacity 54 l, 1 x Lid 13 l
- Type of installation: side-wall-mounted, self-adjusting to 16 - 19 mm side walls
- Slides: covered, dampened slides with self-closing device with fully synchronized over-travel
- System-depth: 448 mm
- Sheet metal system Lid
- Colour: Metall & Plastic parts dark-grey
- Product Dimensions: B x T x H, 562-568 x 434 x 370 mm

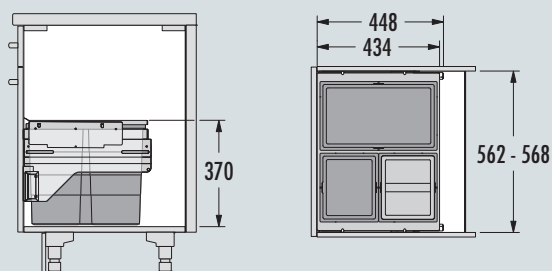

Slide



Für Schränke mit 600 mm Breite mit Frontauszug For cabinets with front-mount-door of 600 mm width

Cargo

Hailo AS Cargo 600 13/13/13/13/D



3610861

NEW



- Trennung: 4-fach
- Abfalleimer: 4 x 13 l, Gesamtvolumen 52 l, 1 Behälterdeckel 13 l
- Montageart: Seitenwandmontage, selbstjustierend 16 - 19 mm
- **Auszugsschienen: abgedeckter, gedämpfter Selbsteinzug mit synchronisiertem Überauszug**
- Systemtiefe: 448 mm
- Metallsystemdeckel
- Farbe: Metallteile & Kunststoffteile dunkelgrau
- Produkt-Maße: B x T x H, 562-568 x 434 x 370 mm

Euro Cargo S

Hailo AS Euro Cargo S 600 30/30



3610621



- Trennung: 2-fach
- Abfalleimer: 2 x 30 l, Gesamtvolumen 60 l
- Montageart: Seitenwandmontage, selbstjustierend 16 - 19 mm
- **Auszugsschienen: abgedeckter, gedämpfter Selbsteinzug**
- Systemtiefe: 448 mm
- Metallsystemdeckel
- Farbe: Metallteile Stahlblech silberfarben
- Produkt-Maße: B x T x H, 562-568 x 403 x 439 mm
- Verpackungsmaße: B x T x H, 490 x 320 x 620 mm
- Gewicht mit Verpackung: 11,45 kg

Euro Cargo S

Hailo AS Euro Cargo S 600 30/13/13/D



3610631



- Trennung: 3-fach
- Abfalleimer: 1 x 30 l, 2 x 13 l, Gesamtvolumen 56 l, 1 x Behälterdeckel 13 l
- Montageart: Seitenwandmontage, selbstjustierend 16 - 19 mm
- **Auszugsschienen: abgedeckter, gedämpfter Selbsteinzug**
- Systemtiefe: 448 mm
- Metallsystemdeckel
- Farbe: Metallteile Stahlblech silberfarben
- Produkt-Maße: B x T x H, 562-568 x 403 x 439 mm
- Verpackungsmaße: B x T x H, 490 x 320 x 620 mm
- Gewicht mit Verpackung: 11,45 kg

- Separation: 4-fold
- Inner bins: 4 x 13 l, Total capacity 52 l, 1 x Lid 13 l
- Type of installation: side-wall-mounted, self-adjusting to 16 - 19 mm side walls
- Slides: covered, dampened slides with self-closing device with fully synchronized over-travel
- System-depth: 448 mm
- Sheet metal system Lid
- Colour: Metall & Plastic parts dark-grey
- Product Dimensions: B x T x H, 562-568 x 434 x 370 mm

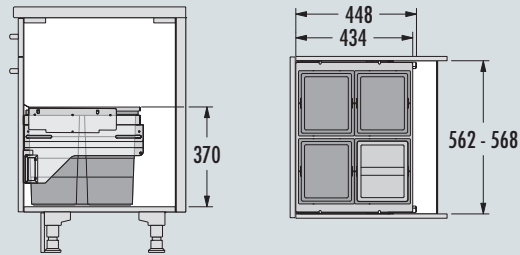

- Separation: 2-fold
- Inner bins: 2 x 30 l, Total capacity 60 l
- Type of installation: side-wall-mounted, self-adjusting to 16 - 19 mm side walls
- Slides: covered, dampened slides with self-closing device
- System-depth: 448 mm
- Sheet metal system Lid
- Colour: Metal parts sheet steel platinum-silver
- Product dimensions: W x D x H, 562 - 568 x 403 x 439 mm
- Packing dimensions: W x D x H, 490 x 320 x 620 mm
- Weight incl. packing: 11,45 kg

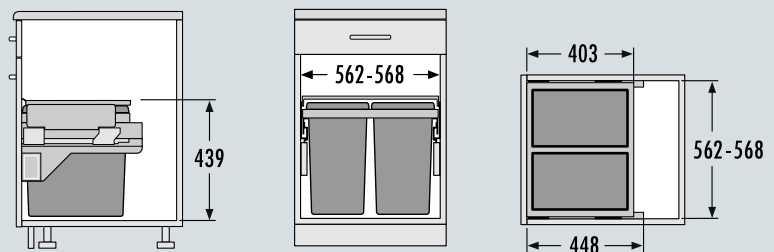

- Separation: 3-fold
- Inner bins: 1 x 30 l, 2 x 13 l, Total capacity 56 l, 1 x Lid 13 l
- Type of installation: side-wall-mounted, self-adjusting to 16 - 19 mm side walls
- Slides: covered, dampened slides with self-closing device
- System-depth: 448 mm
- Sheet metal system Lid
- Colour: Metal parts sheet steel silver-coloured
- Product dimensions: W x D x H, 562 - 568 x 403 x 439 mm
- Packing dimensions: W x D x H, 490 x 320 x 620 mm
- Weight incl. packing: 11,45 kg

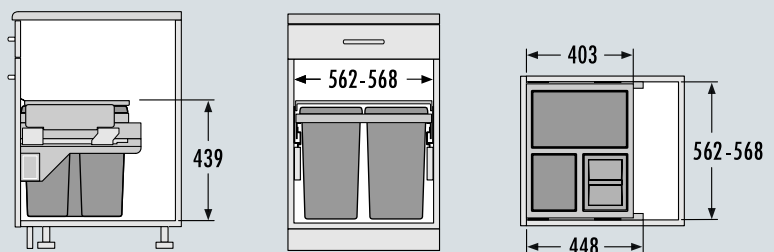

Slide



Für Schränke mit 600 mm Breite mit Frontauszug
For cabinets with front-mount-door of 600 mm width

Cargo Soft kurz
short

Hailo AS Cargo Soft short 600 20/10/10/D

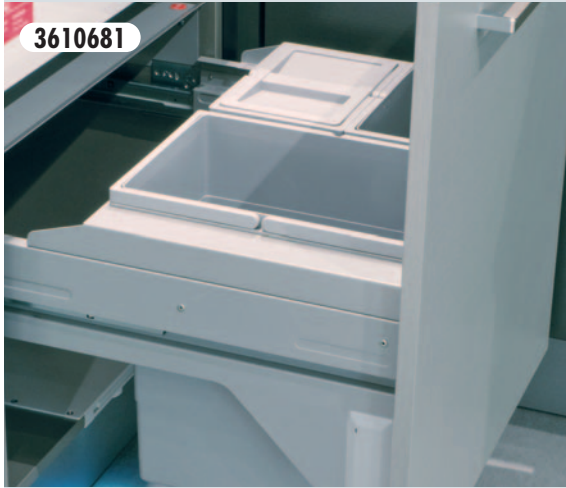

- Trennung: 3-fach
- Abfalleimer: 1 x 20 l, 2 x 10 l, Gesamtvolumen 40 l,
1 x Behälterdeckel 10 l
- Montageart: Seitenwandmontage, selbstjustierend 16 - 19 mm
- **Auszugsschienen: abgedeckter, gedämpfter Selbsteinzug**
- Systemtiefe: 448 mm
- Metallsystemdeckel
- Farbe: Metallteile Stahlblech silberfarben
- Produkt-Maße: B x T x H, 562-568 x 332 x 370 mm
- Verpackungsmaße: B x T x H, 490 x 320 x 620 mm
- Gewicht mit Verpackung: 12,2 kg

- Separation: 3-fold
- Inner bins: 1 x 20 l, 2 x 10 l, Total capacity 40 l
1 x Lid 10 l
- Type of installation: side-wall-mounted, self-adjusting
to 16 - 19 mm side walls mounts also under sink
- **Slides: covered, dampened slides with self-closing device**
- System-depth: 448 mm
- Sheet metal system Lid
- Colour: Metal parts sheet steel silver-coloured,
- Product dimensions: W x D x H, 562-568 x 332 x 370 mm
- Packing dimensions: W x D x H, 490 x 320 x 620 mm
- Weight incl. packing: 12,2 kg

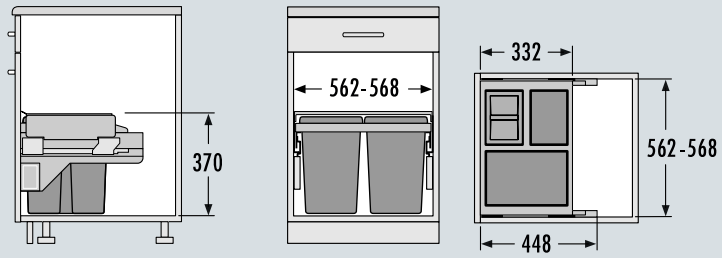

Slide



Für Schränke mit 600 mm Breite mit Frontauszug
For front-mount-door cabinets of 600 mm width

Hailo Kick and Go

Fußhebel

3691301



Fußhebel "Kick and go" für Frontauszüge
und untere Schubkästen

Mehr Infos auf Seite 176

Hailo Libero 2.0

Elektronischer Türöffner

3697201



Hailo Libero – Hands Free Opener
Die Öffnungsunterstützung von Hailo für ein auto-
matisches, komfortables Öffnen aller Abfalltrenn-
systeme mit Frontanbindung und aller Auszugssysteme.

Ausführliche Beschreibung Seite 172

Hailo Libero

Elektronischer Türöffner

3697101



Hailo Libero – Hands Free Opener
Die Öffnungsunterstützung von Hailo für ein auto-
matisches, komfortables Öffnen aller Abfalltrenn-
systeme mit Frontanbindung und aller Auszugssysteme.

Ausführliche Beschreibung Seite 174

Kann in Verbindung mit Metalltüren,
gerahmten Metalltüren und Metall-Sockeln
zu Funktionsstörungen führen.

Foot Pedal

Foot Pedal "Kick and go" for Front mounted door and lower drawer

More information page 176

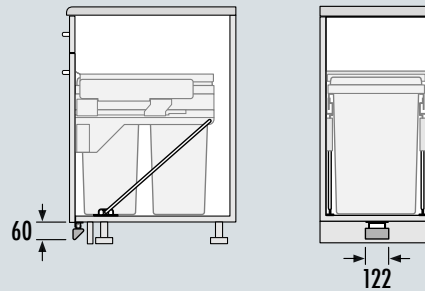

Electronic Door Opener

Hailo „Libero“ – Hands Free Opener

Hailo's electronic front-mount-door and drawer-opener „Libero“ offers an automatic, comfortable hands-free opening of all waste-recycling-systems with attached door-panel and of any common, also damped, drawer-mounted systems.

More information: page 172

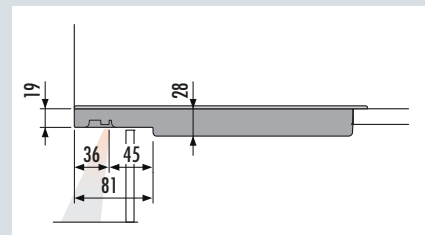
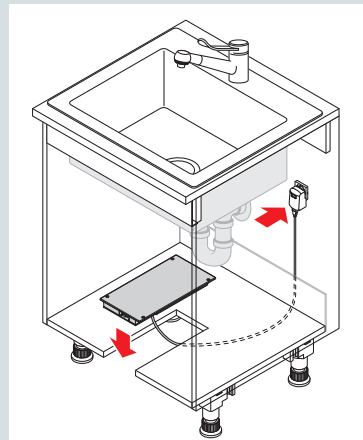

60 cm

Electronic Door Opener

Hailo „Libero“ – Hands Free Opener

Hailo's electronic front-mount-door and drawer-opener „Libero“ offers an automatic, comfortable hands-free opening of all waste-recycling-systems with attached door-panel and of any common, also damped, drawer-mounted systems.

More information page 174

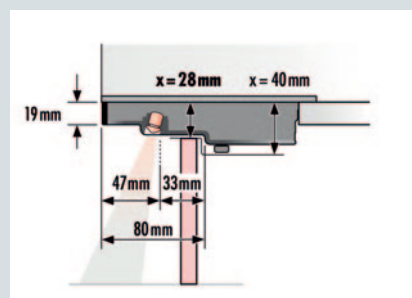

If installed behind a door-panel with a metal frame, or behind a metal cabinet-front, or above a metal plinth, malfunctions may occur.



Übrigens, wussten Sie, ...

dass die Marke Hailo in Deutschland einen Bekanntheitsgrad von etwa 68 % besitzt?

By the way, did you know...

that the Hailo brand enjoys a recognition factor of approx. 68 % in Germany?

Inset



Einsatz für Schränke ab 600 mm Breite mit Frontauszug
For cabinets with drawer, from 600 mm width



60 cm

Inset



Einsatz für Schränke ab 600 mm Breite mit Frontauszug
For cabinets with drawer, from 600 mm width

Triple XL 60

Hailo AS Triple XL 600 28/28

3631681

NEW

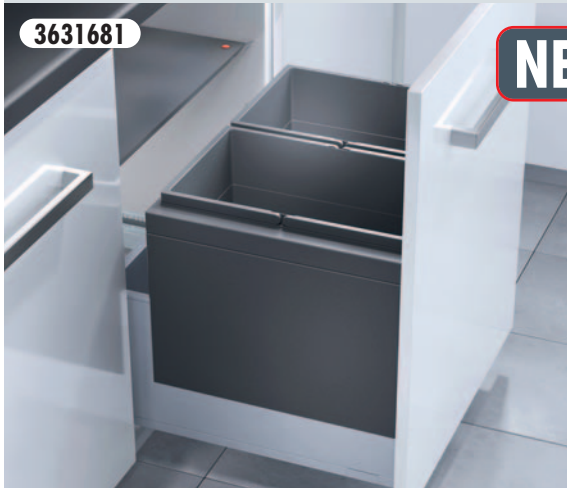

- Trennung: 2-fach
- Abfalleimer: 2 x 28 l, Gesamtvolumen 56 l,
- **Montageart: Schubkastenmontage,** Seitenwandstärke 16 - 19 mm
- Schubkasten Nenntiefe \geq 420 mm
- Metall-Systemdeckel
- Farbe: Metall- und Kunststoffteile dunkelgrau
- Produkt-Maße: T x H, 400 x 402 mm
- Verpackungsmaße: B x T x H, 425 x 305 x 565 mm
- Gewicht mit Verpackung: 9,4 kg

Triple XL 60

Hailo AS Triple XL 600 28/13/13/D

3631691

NEW



- Trennung: 3-fach
- Abfalleimer: 1 x 28 l + 2 x 13 l, Gesamtvolumen 54 l, 1 x Behälterdeckel 13 l
- **Montageart: Schubkastenmontage,** Seitenwandstärke 16 bis 19 mm
- Schubkasten Nenntiefe \geq 420 mm
- Metallsystemdeckel
- Farbe: Metall- und Kunststoffteile dunkelgrau
- Produkt-Maße: T x H, 400 x 402 mm
- Verpackungsmaße: B x T x H, 425 x 305 x 565 mm
- Gewicht mit Verpackung: 9,8 kg

XXL 60

Hailo AS XXL 600 18/D/8,5/8,5/P/P

3630601



- Trennung: 3-fach
- Abfalleimer: 1 x 18 l, 2 x 8,5 l, Gesamtvolumen 35 l, 1 x Behälterdeckel 18 l, 2 x Putzmittelkorb 4,1 l
- **Montageart: Schubkastenmontage,** Seitenwandstärke 16 bis 19 mm
- Schubkasten Nenntiefe \geq 450 mm
- Metallsystemdeckel
- Farbe: Metallteile silberfarben
- Produkt-Maße: T x H, 433 x 330 mm
- Verpackungsmaße: B x T x H, 455 x 315 x 580 mm
- Gewicht mit Verpackung: 9,5 kg



4 007126 364371

- Separation: 2-fold
- Inner bins: 2 x 28 l, Total capacity 56 l
- **Type of installation: inside available drawer,**
side-wall-thickness 16 - 19 mm
- Nominal drawer-depth \geq 420 mm
- Sheet metal system Lid
- Colour: Metal parts powder coated dark-grey,
plastic parts dark-grey
- Product dimensions: D x H, 400 x 402 mm
- Packing dimensions: W x D x H, 425 x 305 x 565 mm
- Weight incl. packing: 9,4 kg

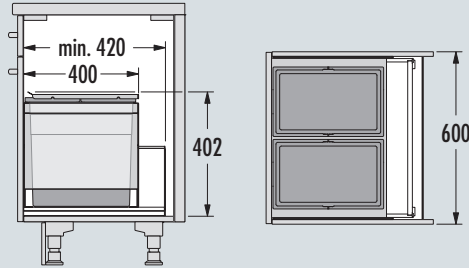

4 007126 364388

- Separation: 3-fold
- Inner bins: 1 x 28 l + 2 x 13 l, Total capacity 54 l,
1 x Lid 13 l
- **Type of installation: inside available drawer,**
side-wall-thickness 16 - 19 mm
- Nominal drawer-depth \geq 420 mm
- Sheet metal system Lid
- Colour: Metal parts powder coated dark-grey,
plastic parts dark-grey
- Product dimensions: D x H, 400 x 402 mm
- Packing dimensions: W x D x H, 425 x 305 x 565 mm
- Weight incl. packing: 9,8 kg

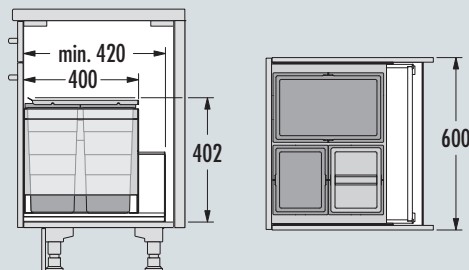

Niedrige Variante
Low Type



4 007126 363053

- Separation: 3-fold
- Inner bins: 1 x 18 l, 2 x 8.5 l, Total capacity 35 l,
1 x Lid 18 l, 2 x Cleansers basket 4.1 l
- **Type of installation: inside available drawer,**
side-wall-thickness 16 - 19 mm
- Nominal drawer-depth \geq 450 mm
- Sheet metal system Lid
- Colour: Metal parts silver-coloured
- Product dimensions: D x H, 433 x 330 mm
- Packing dimensions: W x D x H, 455 x 315 x 580 mm
- Weight incl. packing: 9,5 kg

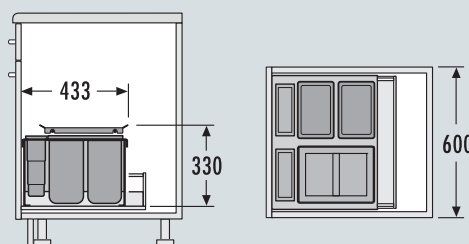

Inset



Einsatz für Schränke ab 600 mm Breite mit Frontauszug
For cabinets with drawer, from 600 mm width

Separato K

Hailo AS Separato K 600 18/8/8/D



- Trennung: 3-fach
- Abfalleimer: 1 x 18 l, 2 x 8 l, Gesamtvolumen 34 l, 1 x Behälterdeckel 8 l
- **Montageart: Schubkastenmontage,** Seitenwandstärke 16 bis 19 mm
- Schubkasten Nenntiefe \geq 500 mm
- Kunststoff-Deckel herausziehbar, Seitenwandmontage
- Farbe: Kunststoffteile hellgrau
- Produkt-Maße: B x T x H, 557 x 491 x 340 mm
- Verpackungsmaße: B x T x H, 570 x 510 x 275 mm
- Gewicht mit Verpackung: 4,7 kg
- Nicht für Blum Legra Box F

- Separation: 3-fold
- Inner bins: 1 x 18 l, 2 x 8 l, Total capacity 34 l
1 x Lid 8 l
- **Type of installation: inside available drawer,**
side-wall-thickness 16 - 19 mm
- Nominal drawer-depth ≥ 500 mm
- Plastic-lid single extension, sidewall-mounted
- Colour: Plastic parts light-grey
- Product dimensions: W x D x H, 557 x 491 x 340 mm
- Packing dimensions: W x D x H, 570 x 510 x 275 mm
- Weight incl. packing: 4,7 kg
- Not suitable for Blum Legra Box F

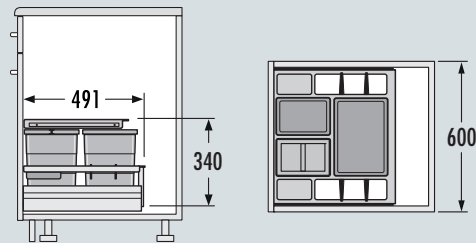



Übrigens, wussten Sie, ...

dass Hailo Einbau-Abfallsammler
ausnahmslos in Deutschland
hergestellt werden?

By the way, did you know...

that Hailo built-in waste
separation systems are exclusively
manufactured in Germany?

Inset



Einsatz für Schränke ab 800 mm Breite mit Frontauszug
For cabinets with drawer, from 800 mm width



80 cm

Inset



Einsatz für Schränke ab 800 mm Breite mit Frontauszug
For cabinets with drawer, from 800 mm width

Triple XL 80

Hailo AS Triple XL 800 28/28/18

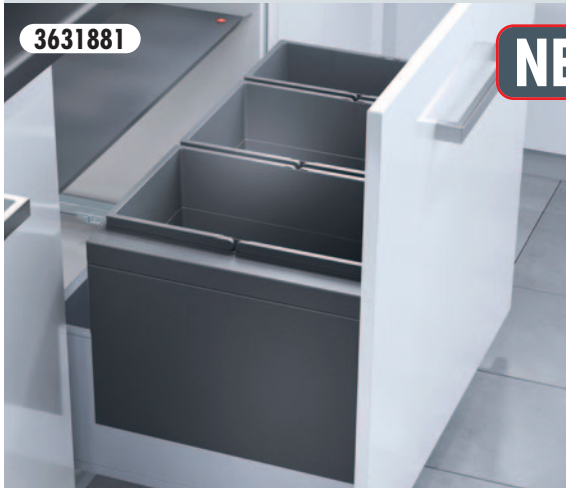

3631881

NEW



- Trennung: 3-fach
- Abfalleimer: 2 x 28 l, 1 x 18 l, Gesamtvolumen 74 l
- **Montageart: Schubkastenmontage,** Seitenwandstärke 16 bis 19 mm
- Schubkasten Nenntiefe \geq 420 mm
- Metallsystemdeckel
- Farbe: Metall- und Kunststoffteile dunkelgrau
- Produkt-Maße: T x H, 400 x 402 mm
- Verpackungsmaße: B x T x H, 775 x 415 x 320 mm
- Gewicht mit Verpackung: 10,8 kg

XXL 80

Hailo AS XXL 800 18/D/18/D/12/P/P/P



3630801



- Trennung: 3-fach
- Abfalleimer: 2 x 18 l, 1 x 12 l, Gesamtvolumen 48 l, 2 x Behälterdeckel 18 l, 3 x Putzmittelkorb 4,1 l
- **Montageart: Schubkastenmontage,** Seitenwandstärke 16 bis 19 mm
- Schubkasten Nenntiefe \geq 450 mm
- Farbe: Metallteile silberfarben
- Produkt-Maße: T x H, 433 x 300 mm
- Verpackungsmaße: B x T x H, 760 x 275 x 455 mm
- Gewicht mit Verpackung: 9 kg



4 007126 364395

- Separation: 3-fold
- Inner bins: 2 x 28 l, 1 x 18 l, Total capacity 74 l
- **Type of installation: inside available drawer,**
side-wall-thickness 16 - 19 mm
- Nominal drawer-depth ≥ 420 mm
- Sheet metal system Lid
- Colour: Metal parts powder coated dark-grey,
plastic parts dark-grey
- Product dimensions: D x H, 400 x 402 mm
- Packing dimensions: W x D x H, 775 x 415 x 320 mm
- Weight incl. packing: 10,8 kg

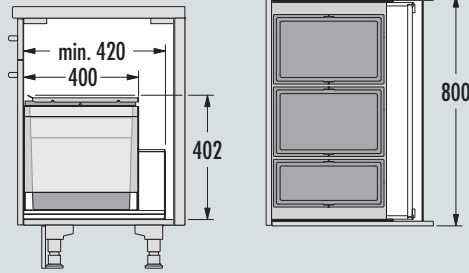

Niedrige Variante
Low Type



4 007126 363077

- Separation: 3-fold
- Inner bins: 2 x 18 l, 1 x 12 l, Total capacity 48 l
2 x Lid 18 l, 3 x Cleanser basket 4.1 l
- **Type of installation: inside available drawer,**
side-wall-thickness 16 - 19 mm
- Nominal drawer-depth ≥ 450 mm
- Colour: Metal parts silver-coloured
- Product dimensions: D x H, 433 x 300 mm
- Packing dimensions: W x D x H, 760 x 275 x 455 mm
- Weight incl. packing: 9 kg

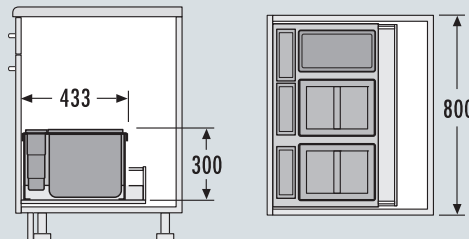

80 cm

Übrigens, wussten Sie, ...

dass Hailo Einbautechnik weltweit
in über 80 Länder exportiert?

By the way, did you know...

that Hailo Built-In Technology
exports to more than 80 countries
around the world?



Inset



Einsatz für Schränke ab 900 mm Breite mit Frontauszug
For cabinets with drawer, from 900 mm width



90 cm

Inset



Einsatz für Schränke ab 900 mm Breite mit Frontauszug
For cabinets with drawer, from 900 mm width

Triple XL 90

Hailo AS Triple XL 900 28/28/28



3631981

NEW



- Trennung: 3-fach
- Abfalleimer: 3 x 28 l, Gesamtvolumen 84 l,
- **Montageart: Schubkastenmontage,** Seitenwandstärke 16 - 19 mm
- Schubkasten Nenntiefe \geq 420 mm
- Metall-Systemdeckel
- Farbe: Metall- und Kunststoffteile dunkelgrau
- Produkt-Maße: T x H, 400 x 402 mm
- Verpackungsmaße: B x T x H, 865 x 415 x 320 mm
- Gewicht mit Verpackung: 10,8 kg

XXL 90

Hailo AS XXL 900 18/D/18/D/12/12/P/P/U/U



3630901



- Trennung: 4-fach
- Abfalleimer: 2 x 18 l, 2 x 12 l, Gesamtvolumen 60 l, 2 x Behälterdeckel 18 l, 2 x Putzmittelkorb 4,1 l, 2 x Utensiliendepot 0,7 l
- **Montageart: Schubkastenmontage,** Seitenwandstärke 16 bis 19 mm
- Schubkasten Nenntiefe \geq 450
- Farbe: Metallteile silberfarben
- Produkt-Maße: T x H, 433 x 300 mm
- Verpackungsmaße: B x T x H, 860 x 275 x 455 mm
- Gewicht mit Verpackung: 10,2 kg

Separato K

Hailo AS Separato K 900 18/18/8/8/D/KS



3620901



- Trennung: 4-fach
- Abfalleimer: 2 x 18 l, 2 x 8 l, Gesamtvolumen 52 l, 1 x Behälterdeckel 8 l
- **Montageart: Schubkastenmontage,** Seitenwandstärke 16 bis 19 mm
- Schubkasten Nenntiefe \geq 500 mm
- Metallsystemdeckel
- Kehrset
- Farbe: Kunststoffteile hellgrau
- Produkt-Maße: B x T x H, 860 x 491 x 340 mm
- Verpackungsmaße: B x T x H, 880 x 530 x 300 mm
- Gewicht mit Verpackung: 8 kg
- Nicht für Blum Legra Box F

- Separation: 3-fold
- Inner bins: 3 x 28 l, Total capacity 84 l
- **Type of installation: inside available drawer,**
side-wall-thickness 16 - 19 mm
- Nominal drawer-depth \geq 420 mm
- Sheet metal system Lid
- Colour: Metal parts powder coated dark-grey,
plastic parts dark-grey
- Product dimensions: D x H, 400 x 402 mm
- Packing dimensions: W x D x H, 865 x 415 x 320 mm
- Weight incl. packing: 10,8 kg

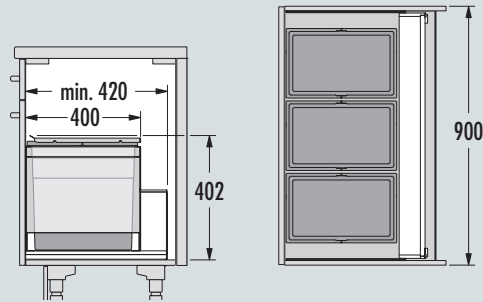

Niedrige Variante Low Type

- Separation: 4-fold
- Inner bins: 2 x 18 l, 2 x 12 l, Total capacity 60 l
2 x Lid 18 l, 2 x Cleaners basket 4.1 l,
2 x utensil depot 0.7 l
- **Type of installation: inside available drawer,**
side-wall-thickness 16 - 19 mm
- Nominal drawer-depth \geq 450 mm
- Colour: Metal parts silver-coloured
- Product dimensions: D x H, 433 x 300 mm
- Packing dimensions: W x D x H, 860 x 275 x 455 mm
- Weight incl. packing: 10,2 kg

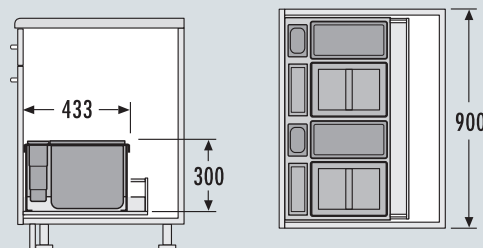

90 cm

- Separation: 4-fold
- Inner bins: 2 x 18 l, 2 x 8 l, Total capacity 52 l
1 x Lid 8 l
- **Type of installation: inside available drawer,**
side-wall-thickness 16 - 19 mm
- Nominal drawer-depth \geq 500 mm
- Sheet metal system Lid, silver-coloured, sidewall-mounted
- Dust-pan with brush
- Colour: Plastic parts light-grey, plastic frame
- Product dimensions: W x D x H, 860 x 491 x 340 mm
- Packing dimensions: W x D x H, 880 x 530 x 300 mm
- Weight incl. packing: 8 kg
- Not suitable for Blum Legra Box F

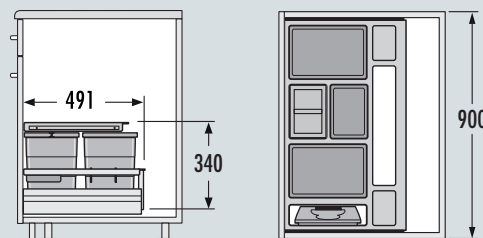

Inset



Einsatz für Schränke ab 900 mm Breite mit Frontauszug
For cabinets with drawer, from 900 mm width

Separato K

Hailo AS Separato K 900 18/18/8/8/D/KS

3620911



- Trennung: 4-fach
- Abfalleimer: 2 x 18 l, 2 x 8 l, Gesamtvolumen 52 l, 1 x Behälterdeckel 8 l
- **Montageart: Schubkastenmontage**, Seitenwandstärke 16 bis 19 mm
- Schubkasten Nenntiefe \geq 500 mm
- Kunststoff-Deckel herausziehbar
- Kehrset
- Farbe: Kunststoffteile hellgrau
- Produkt-Maße: B x T x H, 860 x 491 x 340 mm
- Verpackungsmaße: B x T x H, 880 x 530 x 300 mm
- Gewicht mit Verpackung: 7,7 kg
- Nicht für Blum Legra Box F



- Separation: 4-fold
- Inner bins: 2 x 18 l, 2 x 8 l, Total capacity 52 l
1 x Lid 8 l
- **Type of installation: inside available drawer,**
side-wall-thickness 16 - 19 mm
- Nominal drawer-depth ≥ 500 mm
- Plastic-lid single extension, sidewall-mounted
- Dust-pan with brush
- Colour: Plastic parts light-grey, plastic frame
- Product dimensions: W x D x H, 860 x 491 x 340 mm
- Packing dimensions: W x D x H, 880 x 530 x 300 mm
- Weight incl. packing: 7,7 kg
- Not suitable for Blum Legra Box F

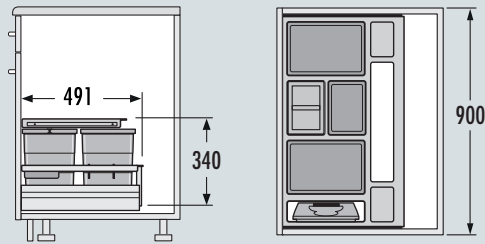



Übrigens, wussten Sie, ...

dass der Hailo Rondo das erste ganzheitliche Abfalltrenn- und Ordnungssystem für Eckspülenschränke war und bis heute als das Original schlechthin gilt.

By the way, did you know...

that the Hailo Rondo is the first integrated waste separation and order system for corner sink units and is still regarded as the original today?

Für Diagonal-Eckspülenschränke ab 900 mm Breite
For diagonal door corner-sink-cabinets from 900 mm width



90 cm

Für Diagonal-Eckspülenschränke ab 900 mm Breite For diagonal door corner-sink-cabinets from 900 mm width

Rondo®

Hailo AS Rondo® 18/18/ME

3645121

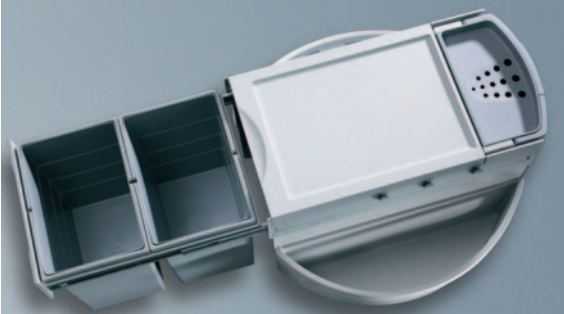

- Trennung: 2-fach, drehbar
- Abfalleimer: 2 x 18 l, Gesamtvolumen 36 l, 1 x Multifunktionseimer 12 l mit Lochdeckel, 2 x Utensilienschalen
- Montageart: Bodenmontage, 360° drehbar
- **Auszugsschienen: Vollauszug**
- Farbe: Metallteile silberfarben, weiß, Kunststoffteile hellgrau
- Einbau-Maße: B x T x H, 336 x 700 x 351 mm
- Produkt-Maße: Ø 700 mm
- Verpackungsmaße: B x T x H, 680 x 560 x 410 mm
- Gewicht mit Verpackung: 12,5 kg

Rondo®

Hailo AS Rondo® 18/8/8/D/ME

3646131

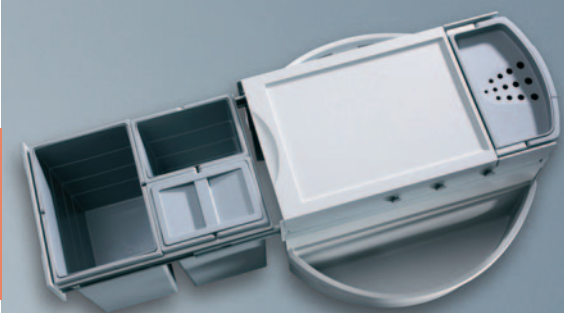

- Trennung: 3-fach, drehbar
- Abfalleimer: 1 x 18 l, 2 x 8 l, Gesamtvolumen 34 l, 1 x Multifunktionseimer 12 l mit Lochdeckel, 2 x Utensilienschalen, 1 x Behälterdeckel 8 l
- Montageart: Bodenmontage, 360° drehbar
- **Auszugsschienen: Vollauszug**
- Farbe: Metallteile silberfarben, weiß, Kunststoffteile hellgrau
- Einbau-Maße: B x T x H, 336 x 700 x 351 mm
- Produkt-Maße: Ø 700 mm
- Verpackungsmaße: B x T x H, 680 x 560 x 410 mm
- Gewicht mit Verpackung: 13 kg

Rondo®

Hailo AS Rondo® 8/8/8/8/D/ME

3647141

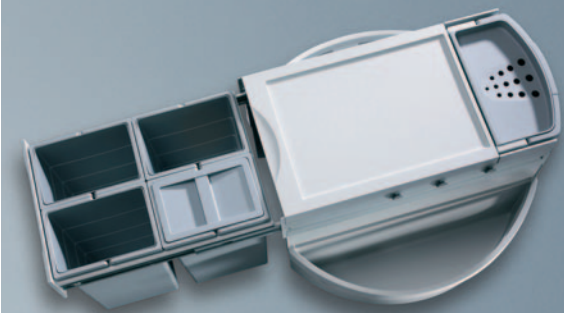

- Trennung: 4-fach, drehbar
- Abfalleimer: 4 x 8 l, Gesamtvolumen 32 l, 1 x Multifunktionseimer 12 l mit Lochdeckel, 2 x Utensilienschalen, 1 x Behälterdeckel 8 l
- Montageart: Bodenmontage, 360° drehbar
- **Auszugsschienen: Vollauszug**
- Farbe: Metallteile silberfarben, weiß, Kunststoffteile hellgrau
- Einbau-Maße: B x T x H, 336 x 700 x 351 mm
- Produkt-Maße: Ø 700 mm
- Verpackungsmaße: B x T x H, 680 x 560 x 410 mm
- Gewicht mit Verpackung: 13,1 kg

- Separation: 2-fold, swivelling
- Inner bins: 2 x 18 l, Total capacity 36 l,
1 x Multifunctional bucket 12 l with perforated lid,
2 x Utensil-side-baskets
- Type of installation: bottom mounted, Turnable 360°
- Slides: full extension
- Colour: Metal parts silver-coloured, white, Plastic parts light grey
- Built-in dimensions: W x D x H, 336 x 700 x 351 mm
- Product dimensions: Ø 700 mm
- Packing dimensions: W x D x H, 680 x 560 x 410 mm
- Weight incl. packing: 12,5 kg

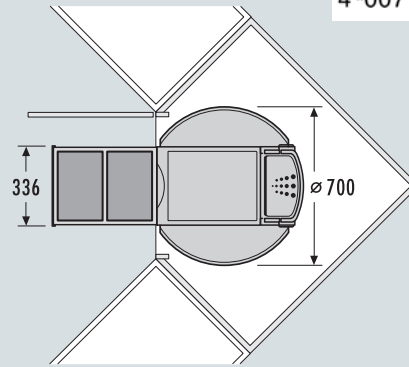
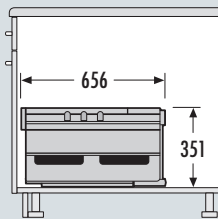

- Separation: 3-fold, swivelling
- Inner bins: 1 x 18 l, 2 x 8 l, Total capacity 34 l,
1 x Multifunctional bucket 12 l with perforated lid,
2 x Utensil-side-baskets, 1 x Lid 8 l
- Type of installation: bottom mounted, Turnable 360°
- Slides: full extension
- Colour: Metal parts silver-coloured, white, Plastic parts light grey
- Built-in dimensions: W x D x H, 336 x 700 x 351 mm
- Product dimensions: Ø 700 mm
- Packing dimensions: W x D x H, 680 x 560 x 410 mm
- Weight incl. packing: 13 kg

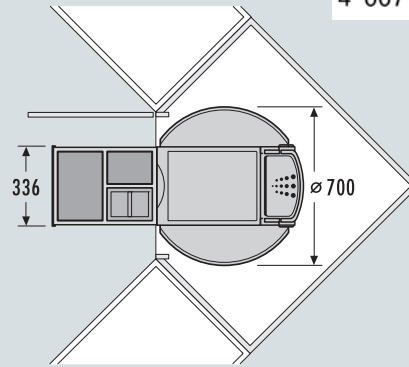
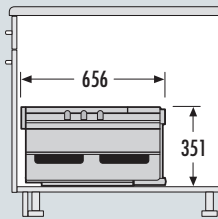

- Separation: 4-fold, swivelling
- Inner bins: 4 x 8 l, Total capacity 32 l,
1 x Multifunctional bucket 12 l with perforated lid,
2 x Utensil-side-baskets, 1 x Lid 8 l
- Type of installation: bottom mounted, Turnable 360°
- Slides: full extension
- Colour: Metal parts silver-coloured, white, Plastic parts light grey
- Built-in dimensions: W x D x H, 336 x 700 x 351 mm
- Product dimensions: Ø 700 mm
- Packing dimensions: W x D x H, 680 x 560 x 410 mm
- Weight incl. packing: 13,1 kg

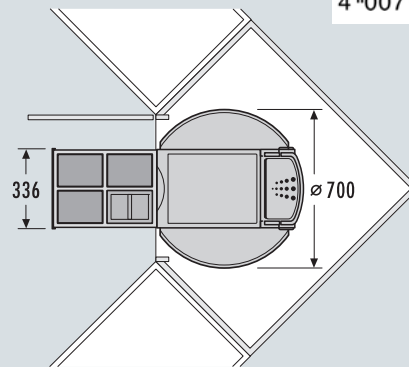
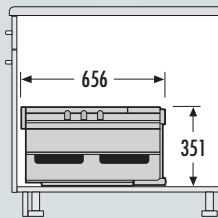

90 cm

Für Diagonal-Eckspülenschränke ab 900 mm Breite For diagonal door corner-sink-cabinets from 900 mm width

Rondo® Comfort

3645221



Hailo AS Rondo® Comfort 20/20/KS/ME

- Trennung: 2-fach, drehbar
- Abfalleimer: 2 x 20 l, Gesamtvolumen 40 l, 1 x Multifunktionseimer 12 l mit Lochdeckel, 2 x Utensilienschalen
- Montageart: Bodenmontage, 360° drehbar
- **Auszugsschienen: Vollauszug**
- Mit integriertem Kehr-Set, Kunststoff rot
- Farbe: Metallteile silberfarben, weiß, Kunststoffteile hellgrau
- Einbau-Maße: B x T x H, 336 x 700 x 406 mm
- Produkt-Maße: Ø 700 mm
- Verpackungsmaße: B x T x H, 680 x 620 x 410 mm
- Gewicht mit Verpackung: 14,0 kg

Rondo® Comfort

3646231



Hailo AS Rondo® Comfort 20/10/10/D/KS/ME

- Trennung: 3-fach, drehbar
- Abfalleimer: 1 x 20 l, 2 x 10 l, Gesamtvolumen 40 l, 1 x Multifunktionseimer 12 l mit Lochdeckel, 2 x Utensilienschalen, 1 x Behälterdeckel 10 l
- Montageart: Bodenmontage, 360° drehbar
- **Auszugsschienen: Vollauszug**
- Mit integriertem Kehr-Set, Kunststoff rot
- Farbe: Metallteile silberfarben, weiß, Kunststoffteile hellgrau
- Einbau-Maße: B x T x H, 336 x 700 x 406 mm
- Produkt-Maße: Ø 700 mm
- Verpackungsmaße: B x T x H, 680 x 620 x 410 mm
- Gewicht mit Verpackung: 15 kg

Schlauchbrausenabweiser

3693001

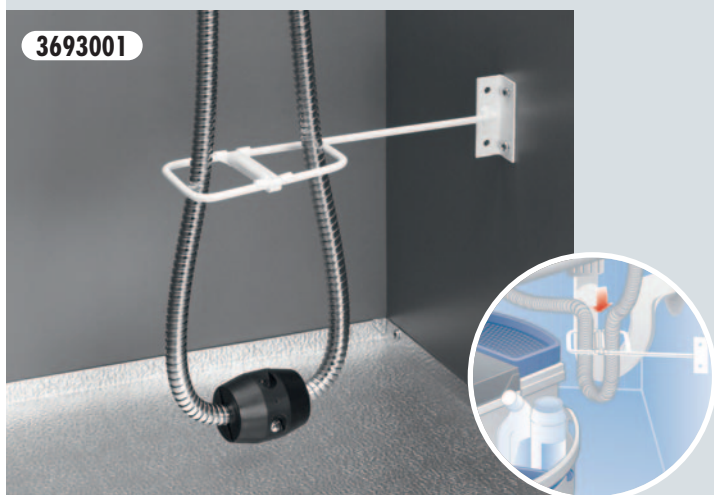

Metallbügel zum Einbau in Spülenunterschränke zur gezielten Schlauchführung.

- Verpackungseinheit: 5
- Verpackungsmaße: B x T x H, 445 x 190 x 85 mm
- Gewicht mit Verpackung: 0,2 kg

- Separation: 2-fold, swivelling
- Inner bins: 2 x 20 l, Total capacity 40 l
1 x Multifunctional bucket 12 l with perforated lid,
2 x Utensil-side-baskets
- Type of installation: bottom mounted, Turnable 360°
- Slides: full extension
- With dust-pan and a brush, Plastic red
- Colour: Metal parts silver-coloured, white,
Plastic parts light grey
- Built-in dimensions: W x D x H, 336 x 700 x 406 mm
- Product dimensions: Ø 700 mm
- Packing dimensions: W x D x H, 680 x 620 x 410 mm
- Weight incl. packing: 14,0 kg

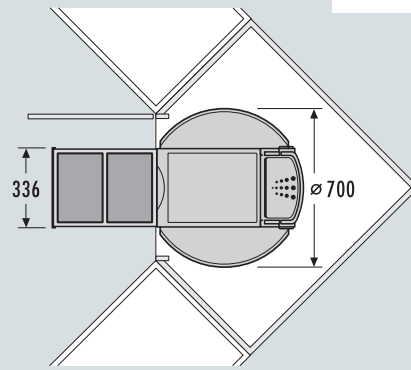
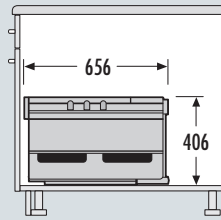

- Separation: 3-fold, swivelling
- Inner bins: 1 x 20 l, 2 x 10 l, Total capacity 40 l,
1 x Multifunctional bucket 12 l with perforated lid,
2 x Utensil-side-baskets, 1x Lid 10 l
- Type of installation: bottom mounted, Turnable 360°
- Slides: full extension
- With dust-pan and a brush, Plastic red
- Colour: Metal parts silver-coloured, white,
Plastic parts light grey
- Built-in dimensions: W x D x H, 336 x 700 x 406 mm
- Product dimensions: Ø 700 mm
- Packing dimensions: W x D x H, 680 x 620 x 410 mm
- Weight incl. packing: 15 kg

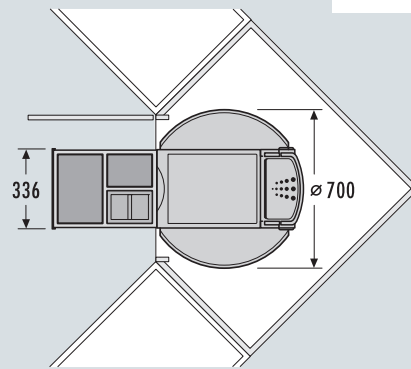
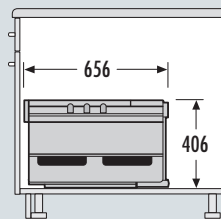

90 cm

Wall-Bracket for Flex-Hose

Wire bracket for sink-cabinets,
for rerouting of flexible hoses.

- Packing unit: 5 each per carton
- Packing dimensions: W x D x H, 445 x 190 x 85 mm
- Weight incl. packing: 0,2 kg



Ordnungssysteme

Organizer systems



<p>Pantry Box</p>		<p>Seite/ Page 147 - 149</p>
<p>On Top System</p>		<p>Seite/ Page 148 - 149</p>
<p>Handtuchhalter Towel Rail</p>		<p>Seite/ Page 151 - 155</p>
<p>Deposito Regalsystem Deposito Rack System</p>		<p>Seite/ Page 157 - 159</p>
<p>Vario</p>		<p>Seite/ Page 161 - 163</p>
<p>Carry</p>		<p>Seite/ Page 165 - 167</p>



Übrigens, wussten Sie, ...

dass Hailo im Verzeichnis „Marken des Jahrhunderts“ neben anderen 300 Premiummarken vertreten ist?

By the way, did you know...

that Hailo is amongst 300 premium brands listed in the “Brands of the Century” guide?

Hailo Pantry-Box.

Hailo Pantry-Box.



reddot award 2016
winner

Inset



Einsatz für Schränke mit 600 mm Breite und Frontauszug
For cabinets with drawer, from 600 mm width

Hailo Pantry Box

3960601



- Für Unterschränke 600 mm Breite
- Inklusive einer Tragebox
- Inklusive Holzrost für Backwaren und Kunststoffrost für Gemüse
- **Montageart: Schubkasteneinsatz für alle handelsüblichen Schubkastensysteme** (Seitenwandstärken 16 bis 19 mm)
- Farbe: Kunststoffteile weiß
- Produkt-Maße: T x H, 491 x 232 mm
- Schubkasten Nenntiefe: 500 mm
- Verpackungsmaße: B x T x H, 730 x 600 x 330 mm
- Gewicht mit Verpackung: 9,6 kg

Hailo On Top System

3205601

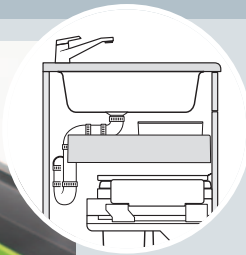

Hailo On Top System

- Behälter: 2 x 4 l, hellgrün/weiß, 2 x Behälterdeckel 4 l
- Tablarauszug aus Kunststoff ausziehbar, Teilauszug
- Farbe: Kunststoffteile hellgrau
- Auszug/Produkt-Maße: B x T x H, 562 x 400 x 109 mm
- Verpackungsmaße: B x T x H, 570 x 410 x 140 mm
- Gewicht mit Verpackung: 3,7 kg

ideal kombinierbar mit allen 60er-Slide-Systemen
(3610121, -131, -471, -521, -531, -621, -631)



- For 600 mm wide drawer-cabinets
- Including Carry-Box (transportable plastic container with handle)
- Including wooden grid for bakery products and plastic grid for vegetables
- Type of installation: for any common standard-drawers in boxed kitchen- and base-cabinets (with sidewall thickness from 16 to 19mm)
- Plastic parts white
- Product dimensions: D x H, 491 x 232 mm
- Nominal depth 500 mm
- Packing dimensions: W x D x H, 730 x 600 x 330 mm
- Weight incl. packing 9,6 kg

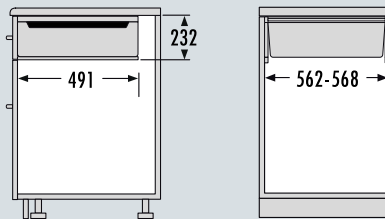

- Container: 2 x 4 l light green/white, 2 x Lid 4 l
- Type of installation: For any common drawer
- Plastic-Pullout single extension lid
- Plastic parts light-grey
- Pullout/Product Dimensions: B x T x H, 562 x 400 x 109 mm
- Packing dimensions: W x D x H, 570 x 410 x 140 mm
- Weight incl. packing 3,7 kg

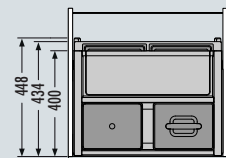
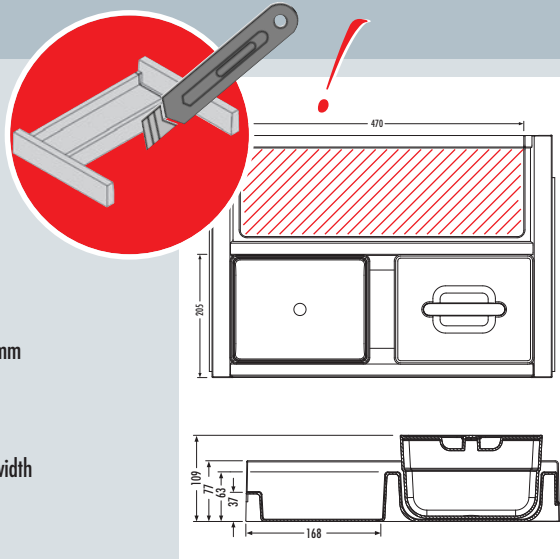

Ideally combinable with all slide systems of 600 mm width (3610121, -131, -471, -521, -531, -621, -631)



Übrigens, wussten Sie, ...

dass die Marke Hailo in Deutschland einen Bekanntheitsgrad von etwa 68 % besitzt?

By the way, did you know...

that the Hailo brand enjoys a recognition factor of approx. 68 % in Germany?

Gut betucht.
Well to do.



Secco S

Handtuchhalter

3151001



- Modell: Secco S
- Haltestangen: 1
- Produkt-Maße: 450 x 200 x 20 mm
- Haltestangen Länge: 450 mm
- Material/Farbe: Kunststoff/hellgrau
- Gewicht: 0,4 kg
- Verpackungsmaße: B x T x H, 460 x 210 x 30 mm

Handtuchhalter

Handtuchhalter mit 2 Haltestangen

3142901



- Modell: Handtuchhalter 2-teilig
- Ausziehstangen: 2
- Produkt-Maße: B x T x H, 119 x 86 x 430 mm
- Ausziehbar von - bis: 430-755 mm
- Metall-/Kunststoffteile weiß
- Gewicht Verpackungseinheit: 4,5 kg
- Verpackungsmaße: B x T x H, 460 x 320 x 130 mm
- **Verpackungseinheit: 10**

Handtuchhalter

Handtuchhalter mit 3 Haltestangen

3143901

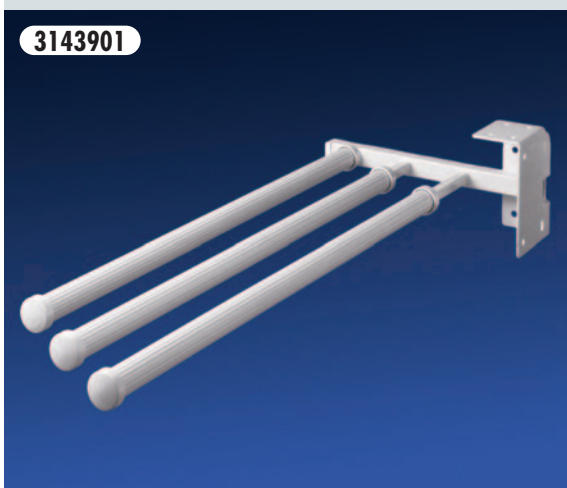

- Modell: Handtuchhalter 3-teilig
- Ausziehstangen: 3
- Produkt-Maße: B x T x H, 168 x 86 x 430 mm
- Ausziehbar von - bis: 430-755 mm
- Metall-/Kunststoffteile weiß
- Gewicht Verpackungseinheit: 6,0 kg
- Verpackungsmaße: B x T x H, 465 x 420 x 130 mm
- **Verpackungseinheit: 10**

Towel Rail

- Model: Secco S
- Holding bars: 1 arms
- Product dimensions: 450 x 200 x 20 mm
- Holding bar, length: 450 mm
- Material/Colour: Plastic/light-grey
- Weight: 0,4 kg
- Packing dimensions: W x D x H, 460 x 210 x 30 mm

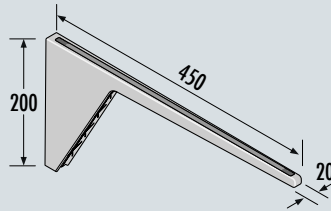

Towel Rail with 2 bars

- Model: Towel rail, double rail
- Pull-out bars: 2 arms
- Product dimensions: W x D x H, 119 x 86 x 430 mm
- To be extended from - to: 430-755 mm
- Metal/plastic parts white
- Weight packing unit: 4,5 kgs
- Packing dimensions: W x D x H, 460 x 320 x 130 mm
- **Packing unit: 10**

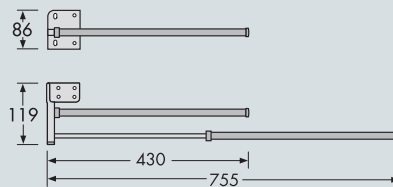

Towel Rail with 3 bars

- Model: Towel rail, triple rail
- Pull-out bars: 3 arms
- Product dimensions: W x D x H, 168 x 86 x 430 mm
- To be extended from - to: 430-755 mm
- Metal/plastic parts white
- Weight packing unit: 6,0 kgs
- Packing dimensions: W x D x H, 465 x 420 x 130 mm
- **Packing unit: 10**

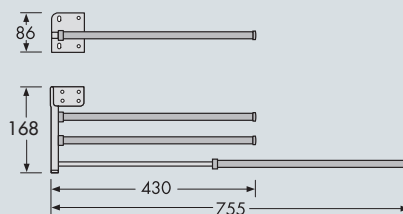

Secco

Handtuchhalter mit 2 Haltestangen



- Modell: Secco mit 2 Haltestangen
- Haltestangen: 2
- Produkt-Maße: B x T x H, 122 x 457 x 30 mm
- Metall-/Kunststoff: Alu/dunkelgrau
- Gewicht: 300 g
- Verpackungsmaße: B x T x H, 455 x 155 x 80 mm

Secco

Handtuchhalter mit 3 Haltestangen



- Modell: Secco mit 3 Haltestangen
- Haltestangen: 3
- Produkt-Maße: B x T x H, 184 x 457 x 30 mm
- Metall-/Kunststoff: Alu/dunkelgrau
- Gewicht: 420 g
- Verpackungsmaße: B x T x H, 455 x 155 x 80 mm

Towel Rail with 2 bars

- Model: Secco with 2 bars
- Holding bars: 2 arms
- Product dimensions: W x D x H, 122 x 457 x 30 mm
- Metal/plastic: alu/dark-grey
- Weight: 300 g
- Packing dimensions: W x D x H, 455 x 155 x 80 mm

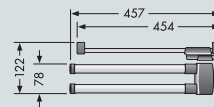
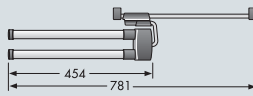

Towel Rail with 3 bars

- Model: Secco with 3 bars
- Holding bars: 3 arms
- Product dimensions: W x D x H, 184 x 457 x 30 mm
- Metal/plastic: alu/dark-grey
- Weight: 420 g
- Packing dimensions: W x D x H, 455 x 155 x 80 mm

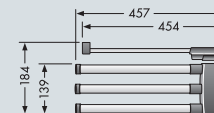
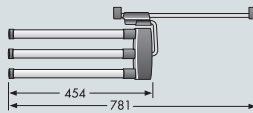



Übrigens, wussten Sie, ... dass Hailo bereits in der Gründungszeit 1947 Abfallsammler produzierte?

By the way, did you know... that Hailo has been producing waste bins right from the outset, early 1947?

Hailo Deposito.

Hailo Deposito.



Deposito



Regalsystem

Flachdunstregal, für 16 mm und 19 mm Seitenwandstärke

- Schrankbreite: 600 mm
- Seitenwände: 16 mm + 19 mm
- Einbaumaße T x H: 72 x 42,5 mm
- Verpackungsmaße: B x T x H, 565 x 120 x 66 mm
- Montageart: Seitenwandmontage
- Metall- und Kunststoffteile: dunkelgrau

- Verpackungseinheit: 2

Deposito



Regalsystem

Flachdunstregal, für 16 mm und 19 mm Seitenwandstärke

- Schrankbreite: 900 mm
- Seitenwände: 16 mm + 19 mm
- Einbaumaße T x H: 72 x 42,5 mm
- Verpackungsmaße: B x T x H, 865 x 120 x 66 mm
- Montageart: Seitenwandmontage
- Metall- und Kunststoffteile: dunkelgrau

- Verpackungseinheit: 2

Rack System

Shelf for extractor fan units with 16 and 19 mm side wall thickness

- Cabinet width: 600 mm
- Side wall thickness: 16 mm + 19 mm
- Built-in dimensions T x H: 72 x 42,5 mm
- Packing dimensions: W x D x H, 565 x 120 x 66 mm
- Kind of installation: side wall mounting
- Metal and plastic parts: dark-grey

- **Packing unit: 2 each per carton**



Rack System

Shelf for extractor fan units with 16 and 19 mm side wall thickness

- Cabinet width: 900 mm
- Side wall thickness: 16 mm + 19 mm
- Built-in dimensions T x H: 72 x 42,5 mm
- Packing dimensions: W x D x H, 865 x 120 x 66 mm
- Kind of installation: side wall mounting
- Metal and plastic parts: dark-grey

- **Packing unit: 2 each per carton**





Übrigens, wussten Sie, ...

dass Hailo Einbautechnik Produkte mit über 100.000 Auszugszyklen getestet werden, bevor sie auf den Markt kommen?

By the way, did you know...

that Hailo Built-In Technology Products are tested on more than 100,000 pull-out cycles before they reach the market?

Hailo Vario.
Hailo Vario.



Swing



Für Schränke ab 200 mm Breite mit Drehtür For hinged door cabinets from 200 mm width

Vario



Einzelauszug

- Der Einzelauszug nutzt sogar den Raum über den Abfalltrennsystemen.
- Metallteile silberfarben, Alu eloxiert/
Kunststoffteile dunkelgrau
- Einbau-Maße: ab 200 mm Schrankbreite
- Produkt-Maße: B x T x H, 155 x 480 x 173 mm
- Montageart: Rechts-/Linksmontage
- Verpackungsmaße: B x T x H, 498 x 188 x 165 mm
- Gewicht mit Verpackung 3,1 kg

Vario



- Das Ordnungssystem Combi Vario nutzt die kleinste Nische als Stauraum.
- Seitenwandmontage, Rechts-/Linksmontage
- Metallteile silberfarben, Alu eloxiert/
Kunststoffteile dunkelgrau
- Einbau-Maße: ab 200 mm Schrankbreite
- Produkt-Maße: B x T x H, 158 x 483 x 481 mm
- Verpackungsmaße: B x T x H, 505 x 170 x 495 mm
- Gewicht mit Verpackung 5,8 kg

Vario



- Seitenwandmontage, Rechts-/Linksmontage
- Metallteile silberfarben, Alu eloxiert/
Kunststoffteile dunkelgrau
- Einbau-Maße: ab 200 mm Schrankbreite
- Produkt-Maße: B x T x H, 158 x 483 x 481 mm
- Verpackungsmaße: B x T x H, 505 x 170 x 495 mm
- Gewicht mit Verpackung 6,45 kg

Vario



- Seitenwandmontage, Rechts-/Linksmontage
- Metallteile silberfarben, Alu eloxiert/
Kunststoffteile dunkelgrau
- Einbau-Maße: ab 200 mm Schrankbreite
- Produkt-Maße: B x T x H, 158 x 483 x 481 mm
- Verpackungsmaße: B x T x H, 505 x 170 x 495 mm
- Gewicht mit Verpackung 5,5 kg

Single pull-out Tray

Passend für Schränke
Suitable for cabinets

30 40 45 50 60 cm

- **The single pull-out Vario-Tray uses even the space above the waste separation system.**
- Metal parts silver-coloured, Aluminium anodized, Plastic parts dark-grey
- Built-in dimensions: from 200 mm Cabinet width
- Product dimensions: W x D x H, 155 x 480 x 173 mm
- Type of installation: Right-/Left-hand sidewall
- Packing dimensions: W x D x H, 160 x 480 x 180 mm
- Weight incl. packing 3,1 kg



- **The Vario-Organizer System uses even the smallest space for storage.**
- Type of installation: Right-/Left-hand sidewall
- Metal parts silver-coloured, Aluminium anodized/ Plastic parts dark-grey
- Built-in dimensions: from 200 mm Cabinet width
- Product dimensions: W x D x H, 158 x 483 x 481 mm
- Packing dimensions: W x D x H, 505 x 170 x 495 mm
- Weight incl. packing 5,8 kg



- Type of installation: Right-/Left-hand sidewall
- Metal parts silver-coloured, Aluminium anodized/ Plastic parts dark-grey
- Built-in dimensions: from 200 mm Cabinet width
- Product dimensions: W x D x H, 158 x 483 x 481 mm
- Packing dimensions: W x D x H, 505 x 170 x 495 mm
- Weight incl. packing 6,45 kg



- Type of installation: Right-/Left-hand sidewall
- Metal parts silver-coloured, Aluminium anodized/ Plastic parts dark-grey
- Built-in dimensions: from 200 mm Cabinet width
- Product dimensions: W x D x H, 158 x 483 x 481 mm
- Packing dimensions: W x D x H, 505 x 170 x 495 mm
- Weight incl. packing 5,5 kg





reddot award



Übrigens, wussten Sie, ...

dass Hailo Produkte bereits
viele Auszeichnungen
erhalten haben?

By the way, did you know...

that Hailo products
have already won many
awards?

Hailo Carry.
Hailo Carry.



Einsatz für Schränke ab 400 mm Breite For cabinets with pull-out shelf from 400 mm width

Hailo Carry



Hailo Carry

Der Hailo Carry ist ausgestattet mit zwei Tragekörben, aufsteckbar auf Auszugssystem mit Selbststeinzug und Dämpfung – schließt sanft und leise.

Durch einfaches herausziehen der mobilen Utensilienkörbe können z.B. Putzmittel zu ihrem Einsatzort getragen werden.

- Schiene gedämpft, abgedeckt
- Farbe hellgrau
- Einbau-Maße: B x T x H, 245 x 459 x 395 mm
- Verpackungsmaße: B x T x H, 504 x 260 x 420 mm
- Gewicht mit Verpackung 6 kg

Hailo Carry

Der Begleiter im Spülenunterschrank. kombinierbar mit unterschiedlichen Hailo-Produkten, z. B. mit unseren bodenmontierten Mülltrennsystemen.

Passend für Schränke
Suitable for cabinets

40 45 50 60 cm



The Hailo Carry comes with carrying Baskets easily removable, transportable, and attachable.

Pullout tray with low-noise, full-extension, self-closing & -dampening slides.

The transportable, utensil Baskets for any cleansers, agents, etc., may be carried to the spot.

- Damped and covered slides
- colour light grey
- Built-In dimensions: W x D x H, 245 x 459 x 395 mm
- Packing dimensions: W x D x H, 504 x 260 x 420 mm
- Weight incl. packing 6 kg

Hailo Carry



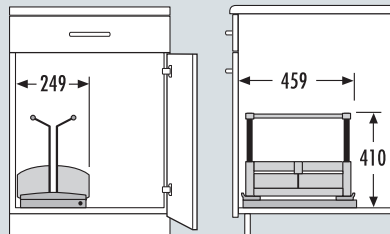

The helper in your sink unit, may be combined with various Hailo products, such as bottom-mount recycling systems.

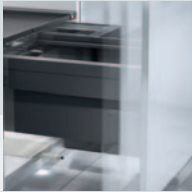

Funktionssysteme

Functional systems



Libero 2.0		Seite/ Page 172 - 173
Libero		Seite/ Page 174 - 175
Kick and go		Seite/ Page 176 - 177
Ausziehtische Pull-out tables		Seite/ Page 179 - 181
Stepfix		Seite/ Page 183 - 185



Übrigens, wussten Sie, ...

dass der Hailo Libero das einzige elektronische Öffnungssystem ist, das individuell bei Auszügen aller Art eingesetzt werden kann?

By the way, did you know...

that the Hailo Libero is the one and only electronic hands-free opening device that may, universally, be used for any type of pull-out?

Hailo **LIBERO**

Hailo **LIBERO**





Hailo Libero 2.0

Die Weiterentwicklung des elektronischen Türöffners Hailo Libero – der Hailo Libero 2.0

Funktionsbeschreibung

Einfache Bedienung durch Fußbetätigung mittels Sensor im Sockelbereich. Die integrierte LED Leuchte dient zur Auffindung des Sensors.

Hailo Libero 2.0

- Für Unterschränke von 300 mm bis 1200 mm Breite
- Montage im vorderen Bereich des Schrankbodens
- Kann einfach nachgerüstet werden
- Niedervoltgerät (5V), mit Micro-USB Buchse
- Stromversorgung über herkömmliche Steckdosen 110 - 230 V, mit 2 m Kabel Micro-USB/ USB Stecker inkl. Netzteil und internationalen Adapter
- **Einfache Bedienung durch Fußsensor**
- Integrierte Auffindbeleuchtung, dimmbar, abschaltbar
- Auswurfstärke einstellbar
- Kein unbeabsichtigtes Öffnen
- Intelligente Steuerung, erkennt Hindernisse dank Rutschkupplung
- Spritzwassergeschützt nach IP 21 Zertifizierung
- Mit europäischen, britischen und nordamerikanischen Zertifizierungen
- Einstellungen und Konfigurationen über Hailo Smartphone App "Hailo Connect" für Android und iOS
- Eigenes WLAN, somit sicher gegen Fremdzugriffe durch das WWW
- Entwicklung und Herstellung in Deutschland
- Abmessungen: 157 mm x 300 mm x 33 mm (BxTxH)
- WEEE-Reg.-Nr.: DE 60802808



HAILO LIBERO

HANDSFREEOPENER

3697201

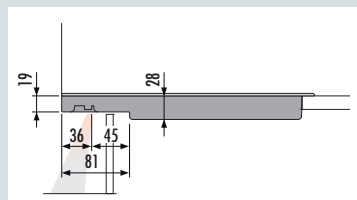
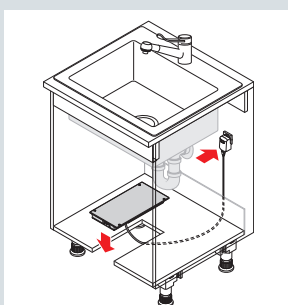

App Hailo Connect



ANDROID



iOS

Automatische Öffnungsunterstützung für alle Auszugssysteme

One opener system for all types of pull-outs, and for side-mounted, self-containing systems



Hailo Libero 2.0

The modified and improved, further development of the unique Hailo HFO – Libero, the new Hailo Libero 2.0, electronic sensor opener, also designed for North America.



Functional description

Easy operation by foot, thanks to a sensor in the plinth-area. The integrated LED light indicates the sensor position.

Hailo Libero 2.0

- For base cabinets from 300 mm to 1200 mm (12 in. to 48 in.) widths
- Mounts in forward section of bottom-panel
- Can also easily be retrofitted
- Low Voltage device, 5 V input, comes with Micro-USB socket
- Power supply by mobile-phone charger/ transformer for 110 V thru 230 V outlets, with 2m Micro-USB/ USB cable and international adapters
- **Easy operation by foot sensor**
- Integrated location lighting, may be dimmed and switched off
- Push-out force adjustable
- No unintended opening
- Intelligent controls, identifies obstacles thanks to friction clutch
- Splash-water proof according to IP 21 certification
- Comes with European, British, and North American Certifications
- Settings and Adjustments via Hailo Smart-Phone App "Hailo Connect" for Android and IOS
- Independent WLAN, secured against access from www.
- Developed and Made in Germany
- Dimensions: 157 mm x 300 mm x 33 mm (WxDxH) 6-1/8 in. x 11-3/4 in. x 1-1/4 in.
- WEEE-Reg.-No: DE 60802808

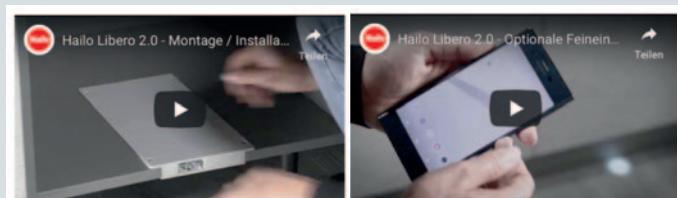

Youtube:
Montagevideos
Installation video

Automatische Türöffner für Auszugssysteme

Automatic Door-Openers/ Toe-Kicks recycling-systems

Hailo Libero



HAILO LIBERO HANDSFREEOPEN

AUSZÜGE ÖFFNEN – AUTOMATISCH UND KOMFORTABEL
Drawers open automatically and easily

Hailo Libero – Hands Free Opener
Die Öffnungsunterstützung von Hailo für ein automatisches, komfortables Öffnen aller Abfalltrennsysteme mit Frontanbindung und aller Auszugssysteme.

Hailo Libero – Hands Free Opener
Hailo's electronic front-mount-door and drawer-opener Libero offers an automatic, comfortable hands-free opening of all waste-recycling-systems with attached door-panel, and of any common, also damped, drawer-mounted systems.

Elektronischer Türöffner

Hailo Libero – Hands Free Opener

Für den meist genutzten Auszug in der Küche, dem Spülen- bzw. Müllschrank, glänzt Hailo Libero mit folgenden Vorteilen:

- Einfache Bedienung durch Fußbetätigung mittels Sensor im Sockelbereich
- Kein unbeabsichtigtes Öffnen beim Anlehnen an die Front
- Integrierte Auffindbeleuchtung (LED)
- Ein System für alle Auszugsarten, ob stehende oder hängende Abfalltrennsysteme
- Einstellbare Auswurfkraft (5-fach justierbar)
- Sanftes Schließen des Abfalltrennsystems mit den gewohnten Lauf- und Dämpfungseigenschaften der jeweiligen Schienen
- Einfacher Einbau ohne Sonderzubehör
- Platzsparende, patentierte Installation im Sockelraum, hinterer Bereich des Schrankes bleibt frei
- Plug-and Play: Netzspannung: 230 V AC +/- 10%
Netzfrequenz: 50 Hz bzw. 60 Hz *
- Produktmaße: 216 x 176 x 42 mm
- Verpackungsmaße: 240 x 220 x 57 mm
- WEEE-Reg.-Nr.: DE 60802808

Kann in Verbindung mit Metalltüren, gerahmten Metalltüren und Metall-Sockeln zu Funktionsstörungen führen.

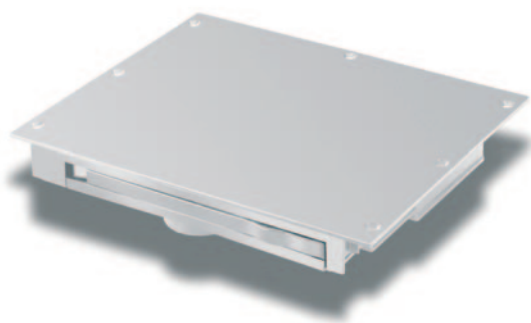

Electronic Door Opener

Hailo Libero – Hands Free Opener

For the most frequently opened pull-out in the kitchen, the waste-recycling-system, the Hailo Libero offers the following advantages:

- Easy operation by foot, thanks to a sensor in the plinth-area
- Integrated identification lighting (LED)
- Not any unintended opening, e.g. by touching of the door-front, or by walking by
- One opener system for all types of pull-outs, or dampened drawers for self-containing systems, for hang-thru bins, for bins standing on the drawer-bottom
- Adjustable push-out forces (5 different settings for any type of slides)
- Soft closing of the recycling-systems, with the known features of used slides
- Easiest installation, within minutes, without any special tooling or accessories
- Space-saving patented installation in the bottom-panel of the cabinet, not any interference with plumbing lines in the rear section
- Plug-and-Play, comes with 230 V (+/-10%), 50-60 Hz, European 2-pin power-plug *
- Built-In dimensions: W x D x H, 216 x 176 x 42 mm
- Packing dimensions: W x D x H, 240 x 220 x 57 mm
- WEEE-Reg.-No: DE 60802808

If installed behind a door-panel with a metal frame, or behind a metal cabinet-front, or above a metal plinth, malfunctions may occur.



HFO

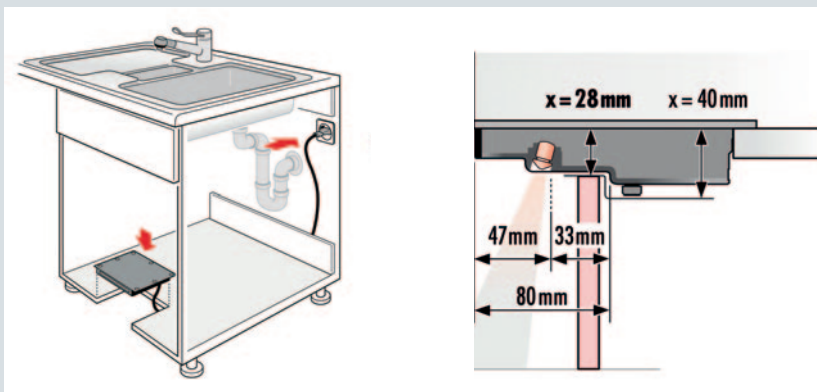

Automatische Türöffner für Auszugssysteme Automatic Door-Openers/ Toe-Kicks recycling-systems

Kick and go

Fußhebel

3691301

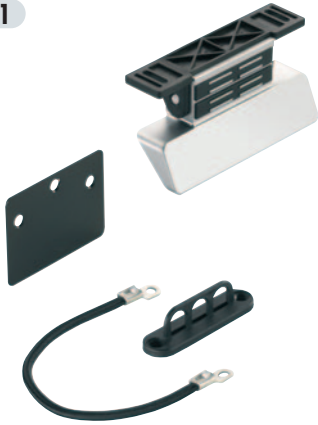

Fußhebel "Kick and go" für Frontauszüge und untere Schubkästen

Kick and go

Türöffner

3692021



Türöffner für Drehtüren

Für Drehtüren ab 300 mm
Federdruckelement aus Kunststoff, mit Fußhebel,
Magnetteil, Metallmagnethalteplatte.

Foot Pedal

Foot Pedal "Kick and go" for Front mounted door and lower drawer

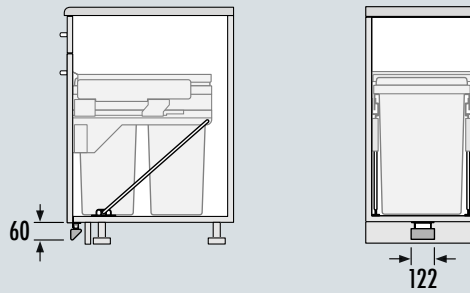

Door-Opener

Door-Opener for hinged doors.

For hinged doors from 300 mm, with magnetic catch, counter-plate, and spring-loaded roller arm.



Übrigens, wussten Sie, ...



dass Hailo bereits in den 50er Jahren als erstes Unternehmen einen Einbau-Ausziehtisch für Küchenmöbel auf den Markt brachte ?

By the way, did you know...

that Hailo, as the first company, introduced a built-in pull-out table for kitchen base-cabinets in the 1950s?

Auszugsweise **Platz.**
Pulled out *Space.*



Auszugsweise Platz.

Pulled out Space.

Rapid



Rapid für 500er Breite

- Modell 3845101
- Dekor Phosphor
- Seitenwände: 16 mm + 19 mm
- Einbau ab Schrankbreite: 500 mm
- Einbau-Maße: B x T x H, 461 x 490 x 120 mm
- Tischplatte/Ausziehfläche: B x L, 421 x 800 mm
- Stufenlos ausziehbar
- Belastbar bis 100 kg
- Gewicht: 10,2 kg
- Verpackungsmaße: B x T x H, 135 x 510 x 470 mm

Rapid



Rapid für 600er Breite

- Modell 3845091
- Dekor Phosphor
- Seitenwände: 16 mm + 19 mm
- Einbau ab Schrankbreite: 600 mm
- Einbau-Maße: B x T x H, 561 x 490 x 120 mm
- Tischplatte/Ausziehfläche: B x L, 521 x 800 mm
- Stufenlos ausziehbar
- Belastbar bis 100 kg
- Gewicht: 11 kg
- Verpackungsmaße: B x T x H, 135 x 510 x 575 mm



- Modell 3845601
- Dekor Weiß
- Seitenwände: 16 mm + 19 mm
- Einbau ab Schrankbreite: 600 mm
- Einbau-Maße: B x T x H, 561 x 490 x 120 mm
- Tischplatte/Ausziehfläche: B x L, 521 x 800 mm
- Stufenlos ausziehbar
- Belastbar bis 100 kg
- Gewicht: 11 kg
- Verpackungsmaße: B x T x H, 135 x 510 x 575 mm



- Modell 3845121
- Dekor Edelstahl
- Seitenwände: 16 mm + 19 mm
- Einbau ab Schrankbreite: 600 mm
- Einbau-Maße: B x T x H, 561 x 490 x 120 mm
- Tischplatte/Ausziehfläche: B x L, 521 x 800 mm
- Stufenlos ausziehbar
- Belastbar bis 100 kg
- Gewicht: 11 kg
- Verpackungsmaße: B x T x H, 135 x 510 x 575 mm

Rapid for width 500 mm

- Type 3845101
- Dekor „Phosphor“
- Side wall thickness: 16 mm + 19 mm
- Min. cabinet width reqd.: 500 mm
- Built-in dimensions: B x T x H, 461 x 490 x 120 mm
- Table extended: W x L, 421 x 800 mm
- Continuously extendible
- Load bearing capacity 100 kg
- Weight: 10,2 kg
- Packed dimensions: W x D x H, 135 x 510 x 470 mm



Rapid for width 600 mm

- Type 3845091
- Dekor „Phosphor“
- Side wall thickness: 16 mm + 19 mm
- Min. cabinet width reqd.: 600 mm
- Built-in dimensions: B x T x H, 561 x 490 x 120 mm
- Table extended: W x L, 521 x 800 mm
- Continuously extendible
- Load bearing capacity 100 kg
- Weight: 11 kg
- Packed dimensions: W x D x H, 135 x 510 x 575 mm

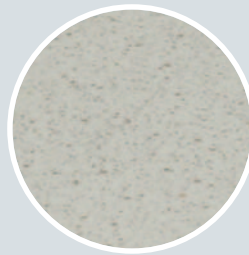

- Type 3845601
- Dekor „white“
- Side wall thickness: 16 mm + 19 mm
- Min. cabinet width reqd.: 600 mm
- Built-in dimensions: B x T x H, 561 x 490 x 120 mm
- Table extended: W x L, 521 x 800 mm
- Continuously extendible
- Load bearing capacity 100 kg
- Weight: 11 kg
- Packed dimensions: W x D x H, 135 x 510 x 575 mm

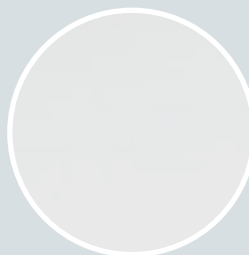

- Type 3845121
- Dekor „steel/alubushed“
- Side wall thickness: 16 mm + 19 mm
- Min. cabinet width reqd.: 600 mm
- Built-in dimensions: B x T x H, 561 x 490 x 120 mm
- Table extended: W x L, 521 x 800 mm
- Continuously extendible
- Load bearing capacity 100 kg
- Weight: 11 kg
- Packed dimensions: W x D x H, 135 x 510 x 575 mm

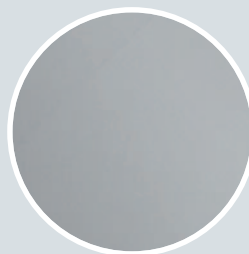



Übrigens, wussten Sie, ...

dass Hailo im Verzeichnis „Marken des Jahrhunderts“ neben anderen 300 Premiummarken vertreten ist?

By the way, did you know...

that Hailo is amongst 300 premium brands listed in the “Brands of the Century” guide?

Sicherer Auftritt.
Save appearance.



Stepfix®

4410001



NEW

- Einbaumaße: B x T x H, 403 x 98 x 470 mm (zusammengeklappt)
- Produktmaße: B x T x H, 403 x 387 x 380 mm (aufgestellt)
- Farbe: Metall- & Kunststoffteile anthrazit
- Tritthöhe: 350 mm
- Verpackungsmaße: B x T x H, 403 x 470 x 100 mm
- Gewicht: 3,9 kg

Stepfix®

4495001



NEW

Wandhalter für Stepfix

- Farbe: Metallteile dunkelgrau
- Produkt-Maße: B x T x H, 144 x 37 x 30 mm
- Verpackungsmaße (10 VE): B x T x H, 197 x 150 x 97 mm
- Gewicht: 0,2 kg
- Verpackungseinheit: 10

Stepfix®

4496001



NEW

Sockelblendenhalter für Stepfix

- Farbe: Metallteile glanzverzinkt
- Produkt-Maße: B x T x H, 357 x 128 x 41 mm
- Verpackungsmaße (10 VE): B x T x H, 445 x 190 x 85 mm
- Gewicht inkl. Verpackung: 0,2 kg
- Verpackungseinheit: 10

- Built-in dimensions: W x D x H, 403 x 98 x 470mm (folded up)
- Product dimensions: W x D x H, 403 x 387 x 380 mm (set up)
- Colour: Metal- & Plastic parts anthracite
- Stepping height: 350 mm
- Packing dimensions: W x D x H, 403 x 470 x 100 mm
- Weight: 3,9 kg

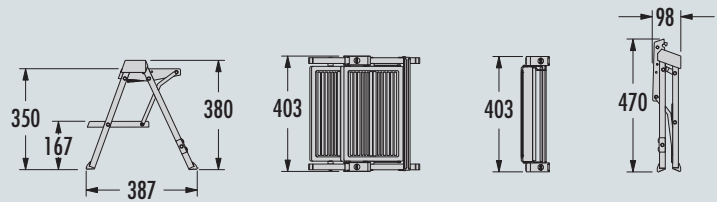

Universal bracket for Stefix

- Colour: Metal parts dark-grey
- Product dimensions: W x D x H, 144 x 37 x 30 mm
- Packing dimensions (10 units): W x D x H, 197 x 150 x 97mm
- Weight: 0,2 kg
- Packing unit 10



Plinth bracket for Stefix

- Colour: Metal parts zinc-coated
- Product dimensions: B x T x H, 357 x 128 x 41 mm
- Packing dimensions (10 VE): B x T x H, 445 x 190 x 85 mm
- Weight incl. packing: 0,2 kg
- Packing unit 10



Wäschepflege / Hauswirtschaftsraum

Laundry care / Utility Room





Laundry Area

Seite/ Page 189 - 197



Laundry Carrier

Seite/ Page 199 - 203



Ordnungs-Module
Organizer Module

Seite/ Page 205 - 211

Übrigens, wussten Sie, ...

dass Hailo Einbautechnik weltweit
in über 80 Länder exportiert?

By the way, did you know...

that Hailo Built-In Technology
exports to more than 80 countries
around the world?



Hailo Laundry Area.

Hailo Laundry Area.



Swing



Für 60 cm breite Schränke.
For 60 cm wide cabinets.

Hailo Laundry Area

Hailo Laundry Area – das Stauraumkonzept für die Wäsche und Zubehör zur Wäschepflege

- Der aufgeräumte Wäscheschrank
- 6 verschiedene Einbaumodule, die individuell nach Bedarf kombiniert werden können
- Werkzeuglose Montage der Einbaumodule
- 60cm breite Schränke unterschiedlicher Höhen können individuell ausgestattet werden
- System jederzeit erweiterbar, nachrüstbar und individuell bestückbar
- Innovative Wandpaneele mit Lochraster werden rechts und links im Schrank verschraubt
- Durch Drehen des Handrades können die Distanzen bei Türscharnieren und verschiedenen Seitenwandstärken entsprechend überbrückt werden (Pin-Screw-Technik) – egal ob rechts oder links angeschlagen.
- Ausgezeichnetes, zeitloses Design – Hohe Materialqualität
- Made in Germany – Original Hailo Qualität



Hailo Laundry-Area – the storage space concept for laundry and laundry-care accessories

- The tidy laundry cupboard
- Six different modules can be combined in line with individual requirements
- No need for tools to install the modules
- 60 cm wide cupboards of varying heights can be fitted individually
- System can be expanded, modified, retrofitted and individually fitted at any time
- Innovative metal wall panels with pre-drilled holes, screwed into place on the right and left side of the base-cabinet or closet
- What's more, the clearance needed for door-hinges is easily adjusted by turning the knurled nuts to get the modules slightly off center – whether left-hand or right-hand hinged doors.
- Outstanding, timeless design – high-end materials
- Made in Germany – original Hailo quality



Das modulare System. Für individuelle Bestückung.



The **Modular** System. For individual organizing.

Beispielbestückungen / Examples of Configurations



Beispiel: 72 cm hoher Schrank
bestückt mit 1 Wäschekorb, Ablageboden,
Bügeltischeinheit

Example: 72 cm high cupboard
Fitted with 1 laundry basket, rigid metal-shelf,
ironing-board unit



Beispiel: 78 cm hoher Schrank
bestückt mit 2 Wäschekörben

Example: 78 cm high cupboard
Fitted with 2 laundry baskets

Perfekt passend für 60 cm breite Drehtürschränke – mit allen gängigen Seitenwandstärken –
egal ob mit rechts oder links angeschlagenen Türen
Perfect fit for 60 cm wide tall cupboards, with standard side-wall thicknesses – with right-hand or left-hand hinged door



Beispiel: 140 cm hoher Schrank
bestückt mit 2 Wäschekörben,
Bügeltischeinheit, Ablageboden,
Utensilienbehälter mit Wandhalter

Example: 140 cm high cupboard
Fitted with 2 laundry baskets,
ironing-board unit, metal-shelf,
accessories boxes with wall-bracket



Beispiel: 190 cm hoher Schrank
bestückt mit 2 Wäschekörben,
Ablageboden, Deckenpaneele,
Stabilisierungswinkel für Korpus

Example: 190 cm high, tall cupboard
Fitted with 2 laundry baskets, rigid metal-shelf,
system cover (with holes for coat-hangers),
and stabilizer-bar for carcass



Beispiel: 210 cm hoher Schrank
bestückt mit 2 Wäschekörben, Bügeltischeinheit,
Mehrzweck-Schublade, Ablageboden,
Deckenpaneele, Stabilisierungswinkel für Korpus

Example: 210 cm high, tall cupboard
Fitted with 2 laundry baskets, ironing-board
unit, multipurpose metal-drawer, rigid metal-
shelf, accessories boxes with wall-bracket,
system cover, and stabilizer-bar for carcass

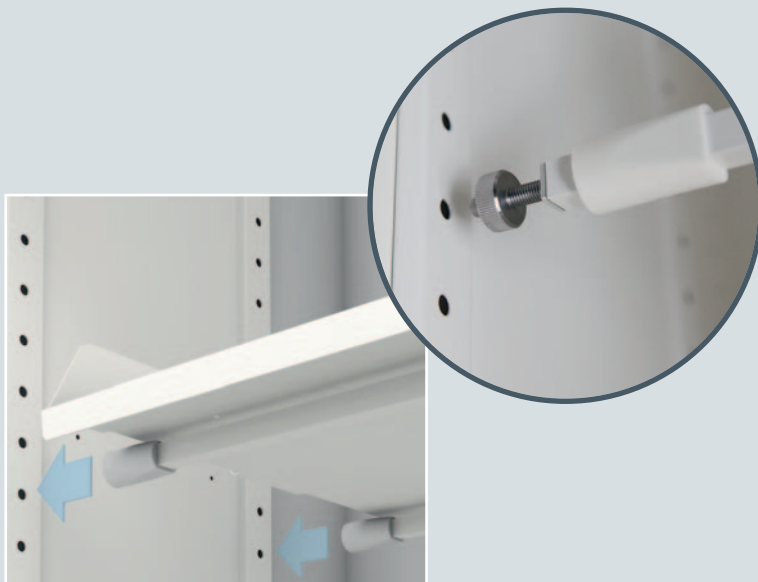

Wandpaneel klein
17 Löcher

Wall-Panel small
with 17 pairs
pre-drilled holes

Wandpaneel groß
28 Löcher

Wall-Panel large
with 28 pairs
pre-drilled holes

Swing



Für 60 cm breite Schränke.
For 60 cm wide cabinets.

Hailo Laundry Area

3271501



2 Utensilienbehälter

2 Utensilienbehälter mit Wandhalter
(zum Einhängen und Herausnehmen)

Benötigte Anzahl der Löcher zur Montage am Wandpaneel 7

- Farbe: Kunststoffteile blau, Metallteile weiß
- Einbau-Maße: B x T x H, 436 x 198 x 241 mm
- Verpackungsmaße: B x T x H, 390 x 220 x 215 mm
- Gewicht mit Verpackung 1,1 kg

Hailo Laundry Area

3271101



Auszug mit Design-Wäschekorb

Auszug mit Design-Wäschekorb für je eine
Waschmaschinenladung (auf Tablarauszug zum Ein- und
Ausfahren sowie zum einfachen Entnehmen)

Benötigte Anzahl der Löcher zur Montage am Wandpaneel 9

- Farbe: Kunststoffteile blau, Metallteile weiß
- Einbau-Maße: B x T x H, 562-578 x 472 x 360 mm
- Verpackungsmaße: B x T x H, 550 x 545 x 395 mm
- Gewicht mit Verpackung 7,7 kg

Hailo Laundry Area

3271201



Mehrzweck-Schublade

Mehrzweck-Schublade für diverse
Utensilien, die zur Wäschepflege nötig sind.

Benötigte Anzahl der Löcher zur Montage am Wandpaneel 5

- Farbe: Kunststoffteile blau, Metallteile weiß
- Einbau-Maße: B x T x H, 562-578 x 468 x 176 mm
- Verpackungsmaße: B x T x H, 550 x 545 x 215 mm
- Gewicht mit Verpackung 7,25 kg

Two Accessories Boxes

Passend für Schränke
Suitable for cabinets

60 cm

Two Accessories Boxes with wall-bracket hanger
space required for fitting to wall-panel = 7 attachment holes' height



- Colour: plastic parts blue, metal parts white
- Built-in dimensions: W x D x H, 436 x 198 x 241 mm
- Packing dimensions: W x D x H, 390 x 220 x 215 mm
- Weight incl. packing 1,1 kg

Metal-Pullout with design Laundry-Basket

Passend für Schränke
Suitable for cabinets

60 cm

Metal-Pullout with design Laundry-Basket,
for one machine load each (on pull-out shelf for sliding in
and out, easily removable) space required for fitting to wall-
panel = 9 attachment holes' height



- Colour: plastic parts blue, metal parts white
- Built-in dimensions: W x D x H, 562-578 x 472 x 360 mm
- Packing dimensions: W x D x H, 550 x 545 x 395 mm
- Weight incl. packing 7,7 kg

Multipurpose Metal-Drawer

Passend für Schränke
Suitable for cabinets

60 cm

Multipurpose Metal-Drawer,
for essential laundry care items space required
for fitting to wall-panel = 5 attachment holes' height



- Colour: plastic parts blue, metal parts white
- Built-in dimensions: W x D x H, 562-578 x 468 x 176 mm
- Packing dimensions: W x D x H, 550 x 545 x 215 mm
- Weight incl. packing 7,25 kg

Swing



Für 60 cm breite Schränke.
For 60 cm wide cabinets.

Hailo Laundry Area

3271301



Ablageboden

Ablageboden fest im Schrank, praktische Ablage für Textilien und sonstiges.
Benötigte Anzahl der Löcher zur Montage am Wandpaneel 3

- Farbe: Metallteile weiß
- Einbau-Maße: B x T x H, 562-578 x 466 x 93 mm
- Verpackungsmaße: B x T x H, 550 x 545 x 215 mm
- Gewicht mit Verpackung 5,25 kg

Hailo Laundry Area

3271801



Deckenpaneel

Deckenpaneel als Stabilitätseinheit des Systems, sowie zum Einhängen von Kleiderbügel.
Ausschließlich für Seitenwände von 16 mm Stärke

- Farbe: Metallteile weiß
- Einbau-Maße: B x T x H, 568 x 323 x 50 mm
- Verpackungsmaße: B x T x H, 580 x 335 x 60 mm
- Gewicht mit Verpackung 1,9 kg

Hailo Laundry Area

3271401



Bügeltischeinheit

Bügeltischeinheit mit praktischem, drehbarem Auszieh-Klapp-Bügeltisch,
Benötigte Anzahl der Löcher zur Montage am Wandpaneel 4

- Einbau-Maße: B x T x H, 562-578 x 466 x 153 mm
- Verpackungsmaße: B x T x H, 550 x 545 x 215 mm
- Gewicht mit Verpackung 15,5 kg

Metal-Shelf

Passend für Schränke
Suitable for cabinets

60 cm

Metal-Shelf, fixed in the cupboard,
handy shelf for textiles and other items.
space required for fitting to wall-panel = 3 attachment holes' height

- Colour: Metal parts white
- Built-In dimensions: W x D x H, 562-578 x 466 x 93 mm
- Packing dimensions: W x D x H, 550 x 545 x 215 mm
- Weight incl. packing 5,25 kg



System Cover

Passend für Schränke
Suitable for cabinets

60 cm

System Cover, horizontal,
sheet-metal with punched holes for cloth hangers,
for use in closets with 16 mm side-walls.

- Colour: Metal parts white
- Built-In dimensions: W x D x H, 568 x 323 x 50 mm
- Packing dimensions: W x D x H, 580 x 335 x 60 mm
- Weight incl. packing 1,9 kg



Ironing-Board Unit

Passend für Schränke
Suitable for cabinets

60 cm

Ironing-Board Unit, pull-out, fold-down & rotating,
for minor laundry.
space required for fitting to wall-panel = 4 attachment holes' height

- Built-In dimensions: W x D x H, 562-578 x 466 x 153 mm
- Packing dimensions: W x D x H, 550 x 545 x 215 mm
- Weight incl. packing 15,5 kg



Swing



Für 60 cm breite Schränke.

For 60 cm wide cabinets.

Hailo Laundry Area

3271601

1

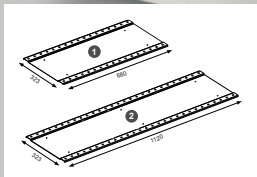

2

3271651

Wandpaneel klein/groß

Wandpaneel klein – 17 Löcher
zum Befestigen der Laundry Area Module

- Farbe: Metallteile weiß
- Einbau-Maße: B x H, 323 x 680 mm
- Verpackungsmaße: B x T x H, 735 x 362 x 48 mm
- Gewicht mit Verpackung 5,1 kg
- Verpackungseinheit: 1 Paar

Wandpaneel groß – 28 Löcher
zum Befestigen der Laundry Area Module

- Farbe: Metallteile weiß
- Einbau-Maße: B x H, 323 x 1120 mm
- Verpackungsmaße: B x T x H, 1190 x 362 x 48 mm
- Gewicht mit Verpackung 8,4 kg
- Verpackungseinheit: 1 Paar

Hailo Laundry Area

3271951



Stabilisierungswinkel

Stabilisierungswinkel für Korpus,
horizontale Verstärkung für höhere Schränke.

- Farbe: Metallteile weiß
- Einbau-Maße: B x T x H, 545-575 x 20 x 42 mm
- Verpackungsmaße: B x T x H, 470 x 55 x 35 mm
- Gewicht mit Verpackung 0,5 kg

Hailo Laundry Area

3271901



Anbau Wäschetrockner

Anbau Wäschetrockner (zum Anbau außen am Schrank
oder an der Wand – klappbar)

- Farbe: Metallteile weiß
- Einbau-Maße: B x T x H, 525 x 820 x 300 mm
- Verpackungsmaße: B x T x H, 740 x 545 x 200 mm
- Gewicht mit Verpackung 3,6 kg

Wall-Panel, small/large

Passend für Schränke
Suitable for cabinets

60 cm

Wall-Panel, small, comes with 17 pairs of pre-drilled holes for fixing of the Laundry Area Modules.

- Colour: Metal parts white
- Built-in dimensions: W x H, 323 x 680 mm
- Packing dimensions: W x D x H, 735 x 362 x 48 mm
- Weight incl. packing 5,1 kg
- Packing unit: 1 pair



Wall-Panel, large, comes with 28 pairs of pre-drilled holes for fixing of the Laundry Area Modules.

- Colour: Metal parts white
- Built-in dimensions: W x H, 323 x 1120 mm
- Packing dimensions: W x D x H, 1190 x 362 x 48 mm
- Weight incl. packing 8,4 kg
- Packing unit: 1 pair



Stabilizer-Bar

Passend für Schränke
Suitable for cabinets

60 cm

Stabilizer-Bar for carcass, adjustable horizontal reinforcement for taller cupboards.

- Colour: Metal parts white
- Built-in dimensions: W x D x H, 545-575 x 20 x 42 mm
- Packing dimensions: W x D x H, 470 x 55 x 35 mm
- Weight incl. packing 0,5 kg



Laundry-Rack

Passend für Schränke
Suitable for cabinets

60 cm

Laundry-Rack, externally wall-mounted, foldaway type, modified metal-parts and metal-bars.

- Colour: Metal parts white
- Built-in dimensions: W x D x H, 525 x 820 x 300 mm
- Packing dimensions: W x D x H, 740 x 545 x 200 mm
- Weight incl. packing 3,6 kg





reddot award



Übrigens, wussten Sie, ... dass Hailo Produkte bereits viele Auszeichnungen erhalten haben?

By the way, did you know... that Hailo products have already won many awards?

Hailo Laundry Carrier.

Hailo Laundry Carrier.



Slide



Für 45 cm, 50 cm oder 60 cm breite Unterschränke.

For 45 cm, 50 cm or 60 cm wide base-cabinets.

Hailo Laundry Carrier 450



3270461

NEW

- Wäschebehälter: 2 x 33 l
- Montageart: Seitenwandmontage, selbstjustierend 16 - 19 mm
- Auszugsschienen: **abgedeckter, gedämpfter Selbsteinzug mit synchronisiertem Überauszug**
- Material, Farbe: Metallteile Stahlblech weiß, Kunststoffteile weiß / blau
- Produkt-Maße: B x T x H 412-418 x 528 x 545 mm
- Systemtiefe: 528 mm
- Verpackungsmaße: B x T x H 490 x 320 x 620 mm
- Gewicht mit Verpackung 13 kg

Hailo Laundry Carrier 500



3270511

NEW

- Wäschebehälter: 2 x 33 l
- Montageart: Seitenwandmontage, selbstjustierend 16 - 19 mm. Inkl. 4 x 25 mm Distanzstücken
- Auszugsschienen: **abgedeckter, gedämpfter Selbsteinzug mit synchronisiertem Überauszug**
- Material, Farbe: Metallteile Stahlblech weiß, Kunststoffteile weiß / blau
- Produkt-Maße: B x T x H 462-468 x 528 x 545 mm
- Systemtiefe: 528 mm
- Verpackungsmaße: B x T x H 490 x 320 x 620 mm
- Gewicht mit Verpackung 13,3 kg

Hailo Laundry Carrier 600



3270611

NEW

- Wäschebehälter: 2 x 33 l, Zusatzbehälter 1 x 12 l, 1 x 2,5 l
- Montageart: Seitenwandmontage, selbstjustierend 16 - 19 mm
- Auszugsschienen: **abgedeckter, gedämpfter Selbsteinzug mit synchronisiertem Überauszug**
- Material, Farbe: Metallteile Stahlblech weiß, Kunststoffteile weiß / blau
- Produkt-Maße: B x T x H 562-568 x 528 x 545 mm
- Systemtiefe: 528 mm
- Verpackungsmaße: B x T x H 590 x 325 x 620 mm
- Gewicht mit Verpackung 15,5 kg

- Baskets capacity: 2 x 33 l
- Type of installation: Sidewall mounting, self-adjust. 16 to 19 mm
- **Slides: covered, dampened slides with self-closing device with fully synchronized over-travel**
- Material, colour: Metal parts sheet-steel white coated, Plastic parts white / blue
- Product dimensions: W x D x H 412-418 x 528 x 545 mm
- System-depth: 528 mm
- Packing dimensions: W x D x H 490 x 320 x 620 mm
- Weight incl. packing 13 kg

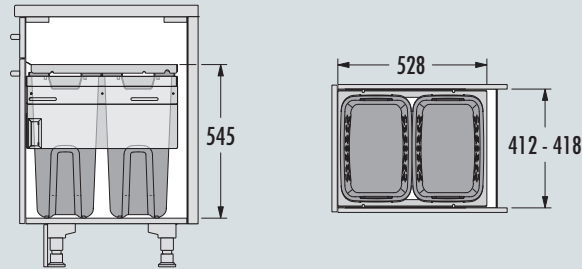

- Baskets capacity: 2 x 33 l
- Type of installation: Sidewall mounting, self-adjust. 16 to 19 mm, incl. 4 x 25 mm spacer-blocks
- **Slides: covered, dampened slides with self-closing device with fully synchronized over-travel**
- Material, colour: Metal parts sheet-steel white coated, Plastic parts white / blue
- Product dimensions: W x D x H 462-468 x 528 x 545 mm
- System-depth: 528 mm
- Packing dimensions: W x D x H 490 x 320 x 620 mm
- Weight incl. packing 13,3 kg

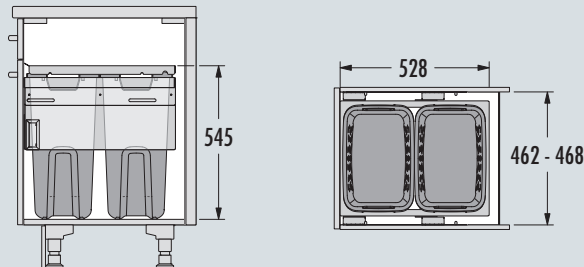

- Baskets capacity: 2 x 33 l
add. Bins 1 x 12 l, 1 x 2,5 l
- Type of installation: Sidewall mounting, self-adjust. 16 to 19 mm
- **Slides: covered, dampened slides with self-closing device with fully synchronized over-travel**
- Material, colour: Metal parts sheet-steel white coated, Plastic parts white / blue
- Product dimensions: W x D x H 562-568 x 528 x 545 mm
- System-depth: 528 mm
- Packing dimensions: W x D x H 590 x 325 x 620 mm
- Weight incl. packing 15,5 kg

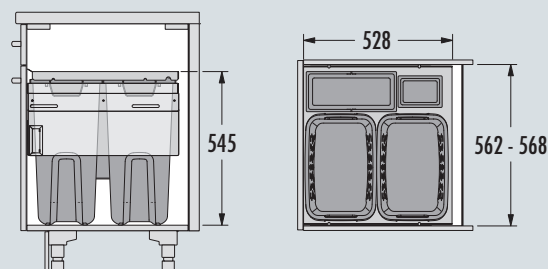

Slide



**Für 60 cm breite Unterschränke.
For 60 cm wide base-cabinets.**

Hailo Laundry Carrier S 600



- Wäschebehälter: 2 x 33 l
- Montageart: Seitenwandmontage, selbstjustierend
16 - 19 mm. Inkl. 4 x 25 mm Distanzstücken
- Auszugsschiene: **abgedeckter, gedämpfter
Selbsteinzug mit Überauszug**
- Material, Farbe: Metallteile Stahlblech weiß,
Kunststoffteile weiß / blau
- Produkt-Maße: B x T x H 562-568 x 448 x 545
- Systemtiefe: 448 mm
- Verpackungsmaße: B x T x H 590 x 325 x 620 mm
- Gewicht mit Verpackung 12,5 kg



- Baskets capacity: 2 x 33 l
- Type of installation: Sidewall mounting, self-adjust. 16 to 19 mm, incl. 4 x 25 mm spacer-blocks
- Slides: covered, dampened slides with self-closing device with over-travel
- Material, colour: Metal parts sheet-steel white coated, Plastic parts white / blue
- Product dimensions: W x D x H 562-568 x 448 x 545
- System-depth: 448 mm
- Packing dimensions: W x D x H 590 x 325 x 620 mm
- Weight incl. packing 12,5 kg

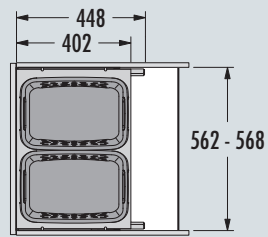
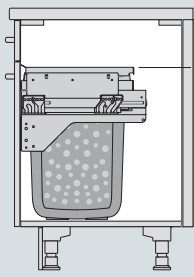

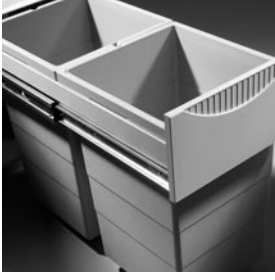

Übrigens, wussten Sie, ...

dass der Hailo Tandem mit über 13 Mio. Exemplaren das meistverkaufte Einbau-Abfalltrennsystem der Welt ist?

By the way, did you know...

that the Hailo Tandem is the most sold fitted waste separation system in the world, with more than 13 million units sold?

Ordnungsmodule

Organizer Systems & Accessories



Swing

Für Schränke mit Drehtür.
For cabinets with hinged door.

Hailo Ordnungs-Module

3271351

NEW

Hailo Universaltablar

Hinweis: Das Universaltablar ist nur für 60er Schränke mit 16 mm Seitenwandstärke geeignet!

Das Universaltablar lässt sich mittels hochwertiger Auszugsschienen herausziehen und eignet sich ideal als Depot für Staubsauger und andere größere Gegenstände. Durch die direkte Montage der Schienen an der Seitenwand des Schrankes ist das Universaltablar hoch belastbar. Auch geeignet zur Lagerung von Getränkeboxen.

- Farbe: Metall- & Kunststoffteile weiß
- Belastbar bis 40 kg
- 2 Auszugsschienen, 1 Abstandhalter
- Produkt-Maße: B x T x H, 568 x 510 x 71 mm (ohne Wäschekorb) / H 314 mm (mit optional erhältlichem Wäschekorb)
- Verpackungsmaße: B x T x H, 550 x 535 x 195 mm
- Gewicht mit Verpackung: 6,7 kg

Hailo Ordnungs-Module

3271661

NEW

Hailo Shoe Rack

Metall-Rack zum Aufsatz auf Universaltablar (3271351). Ideal zum Lagern von Schuhen.

- Farbe: Metallteile weiß
- Systemtiefe: 356 mm
- Produkt-Maße: B x T x H, 496 x 356 x 158 mm
- Verpackungsmaße: B x T x H, 510 x 430 x 245 mm
- Gewicht mit Verpackung 3,8 kg

Hailo Ordnungs-Module

3271361



Hailo Wäschekorb

- Farbe: Kunststoffteile blau oder weiß
- Produktmaße: 520 x 462 x 304 mm
- Verpackungsmaße: 550 x 535 x 375 mm
- Gewicht mit Verpackung: 2,6 kg
- Passgenau für Hailo Universaltablar



1132159

Hailo Universal Pullout

Note: The universal pullout is only suitable for 60 cm cabinets with 16 mm sidewall thickness!

The universal pullout can be pulled out by synchronized, covered overtravel slides and is ideally suited for bottle crates, vacuum cleaners, and other larger items. By the direct mounting of the rails on the sidewall of the cabinet, the universal pullout is highly resilient.

- Colour: Metal & plastic parts white
- Load bearing capacity 40 kg
- 2 synchronized, covered overtravel slides, 1 spacer-block (for hinges side)
- Product dimensions: W x D x H, 568 x 510 x 71 mm (without laundry basket) / H 314 mm (including optional laundry basket)
- Packing dimensions: W x D x H, 550 x 535 x 195 mm
- Weight incl. packing 6,7 kg

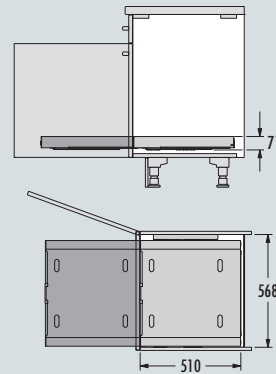

Hailo Shoe Rack

Add-on metal-rack for universal pullout (3271351). Ideal for storing shoes.

- Colour: Metal parts white
- System-depth: 356 mm
- Product-dimensions: W x D x H, 496 x 356 x 158 mm
- Packing dimensions: W x D x H, 510 x 430 x 245 mm
- Weight incl. packing 3,8 kg

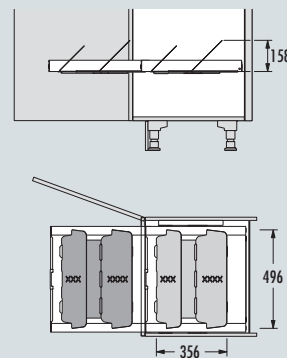

Hailo Laundry basket

- Colour: Plastic parts blue or white
- Product dimensions: W x D x H: 520 x 462 x 304 mm
- Packing dimensions: W x D x H, 550 x 535 x 375 mm
- Weight incl. packing 2,6 kg
- Custom-fit for Hailo universal pullout

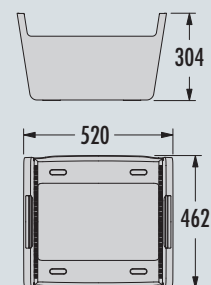
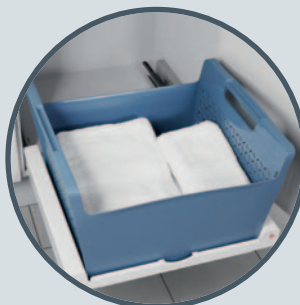

Swing

Für Schränke mit Drehtür.
For cabinets with hinged door.

Hailo Ordnungs-Module

3272111

NEW

Hailo Wertstoff Depot

Das praktische Wertstoffdepot zum Einbau in Schränke oder außen an die Schrankwand.

Trägermodul und große Deckelklappe aus stabilem, pulverbeschichtetem Stahlblech.

Einhängevorrichtung für Müllsäcke oder Stoffbeutel.

Einfache Montage mit nur 4 Schrauben.

- Inklusive stabilem Baumwollsack
- Farbe: Metallteile weiß
- Produkt-Maße: B x T x H, 404 x 261 x 125 mm
- Verpackungsmaße: B x T x H, 420 x 280 x 145 mm
- Gewicht mit Verpackung: 2,3 kg

Hailo Ordnungs-Module

3272161

NEW

Hailo Multifunktionshalterung

Praktische Halterung zur Aufnahme von senkrecht stehenden Gegenständen wie z.B. Bügeltisch und Leiter. Gegenstände werden platzsparend und kippicher verstaut.

- Multifunktionshalterung aus Stahlblech
- Farbe: Metallteile weiß
- Produkt-Maße: B x T x H, 155 x 350 x 50 mm
- Verpackungsmaße: B x T x H, 170 x 365 x 65 mm
- Gewicht mit Verpackung: 1,4 kg
- Verpackungseinheit: 2 Stück

Hailo Ordnungs-Module

3271251

NEW

Hailo Besen-/ Wischerhalter

Besen-/Wischerhalter schafft Platz für die oft sperrigen Besen, Wischer, Schrubber usw. Sauber aufgehängt und sofort griffbereit!

- Einfache Montage mit nur 4 Schrauben
- Trägermodul, Stahlblech
- Farbe: Metallteile weiß
- Produkt-Maße: B x T x H, 137 x 352 x 262 mm
- Verpackungsmaße: B x T x H, 140 x 375 x 290 mm
- Gewicht mit Verpackung: 1,8 kg

Hailo Collector

The handy metal frame with cotton-bag for fitting inside or out-side the cupboard.
Wall Bracket and large Lid made of sturdy powder-coated sheet-metal.

With attachment device for plastic bin-liners or cotton fabric-bags.

Easy installation with just 4 screws.

- comes with sturdy Cotton-Bag
- Colour: Metal parts white
- Product dimensions: W x D x H, 404 x 261 x 125 mm
- Packing dimensions: W x D x H, 420 x 280 x 145 mm
- Weight incl. packing 2,3 kg

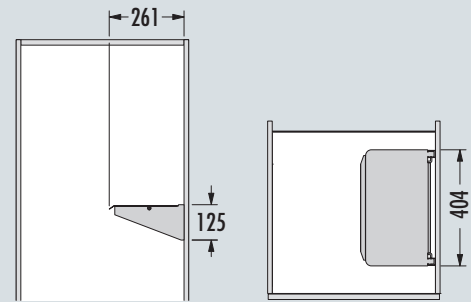

Hailo Multifunctional Holder

Practical holder for holding upright objects, e. g. ironing board and ladder. Objects are stowed space-saving and unable to tip over.

- Multifunctional bracket, made of sheet steel
- Colour: Metal parts white
- Product dimensions: W x D x H, 155 x 350 x 50 mm
- Packing dimensions: W x D x H, 170 x 365 x 65 mm
- Weight incl. packing 1,4 kg
- Packing unit: 2 pieces

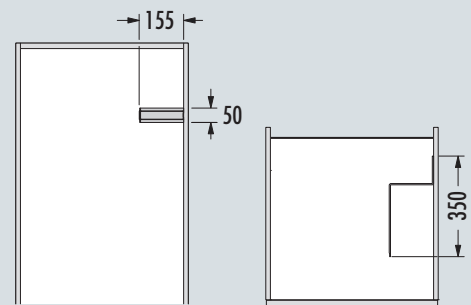

Hailo Broom/Wiper Holder

Broom / Wiper Holder makes room for the often bulky brooms, wipers, scrubbers, etc. Neatly hanged and at once ready to hand!

- Easy installation with 4 screws only
- Carrier bracket, sheet steel
- Colour: Metal parts white
- Product dimensions: W x D x H: 137 x 352 x 262 mm
- Packing dimensions: W x D x H, 140 x 375 x 290 mm
- Weight incl. packing 1,8 kg

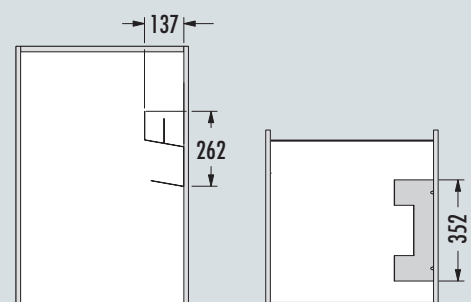

Swing



**Für Schränke mit Drehtür.
For cabinets with hinged door.**

Hailo Ordnungs-Module

3271151

NEW



Hailo Ablage

Ablage (inkl. Kehrset)

Diese Universalablage eignet sich ideal zum Abstellen von Eimern, sonstigen Behältern und vielem mehr. Ein integrierter Haken, unter dem Ablageboard, schafft zusätzlich Aufhängemöglichkeiten für bspw. Tücher und Lappen oder das integrierte Kehr-Set.

- Einfache Montage mit nur 4 Schrauben.
- Trägermodul, Stahlblech, inklusive Kehr-Set
- Farbe: Metallteile weiß
- Produkt-Maße: B x T x H, 289 x 480 x 158 mm (ohne Kehr-Set) / H 305 mm (mit Kehr-Set)
- Verpackungsmaße: B x T x H, 340 x 500 x 125 mm
- Gewicht mit Verpackung: 3,1 kg

Hailo Shelf

Shelf (including sweeping set)

This universal shelf is ideal for storing buckets, other containers, and much more. An integrated hook under the shelf creates additional hanging options, for wipes and cloths, or the integrated sweeping set.





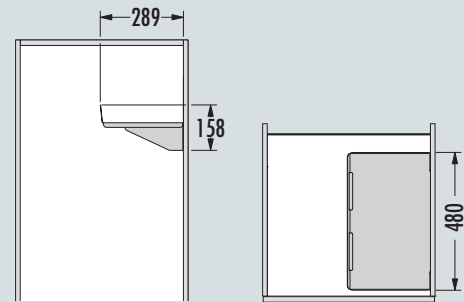

- Easy installation with 4 screws only. Carrier shelf in sheet steel, included sweeping set.
- Colour: Metal parts white
- Product dimensions: W x D x H, 289 x 480 x 158 mm (without sweeping set) / H 305 mm (including sweeping set)
- Packing dimensions: W x D x H, 340 x 500 x 125 mm
- Weight incl. packing 3,1 kg



Eimer, Einsätze, Zubehör

Bins, Inserts, Accessoires



Inneneimer Inner Bins		Seite/ Page 215 - 233
Hailo On Top Behälter Hailo On Top Container		Seite/ Page 235 - 237
Schlauchbrausenabweiser Wall-Bracket for Flex-Hose		Seite/ Page 236 - 237
Kitty		Seite/ Page 238 - 239
Bathroom Kitty		Seite/ Page 238 - 239



Übrigens, wussten Sie, ...

dass Hailo die größte Eimervielfalt für jeden Bedarf vorhält?

By the way, did you know...

that Hailo provides the widest range of bins for all requirements?

Hailo Inneneimer

Hailo Inner Bins



Hailo Inneneimer

Hailo Inner Bins

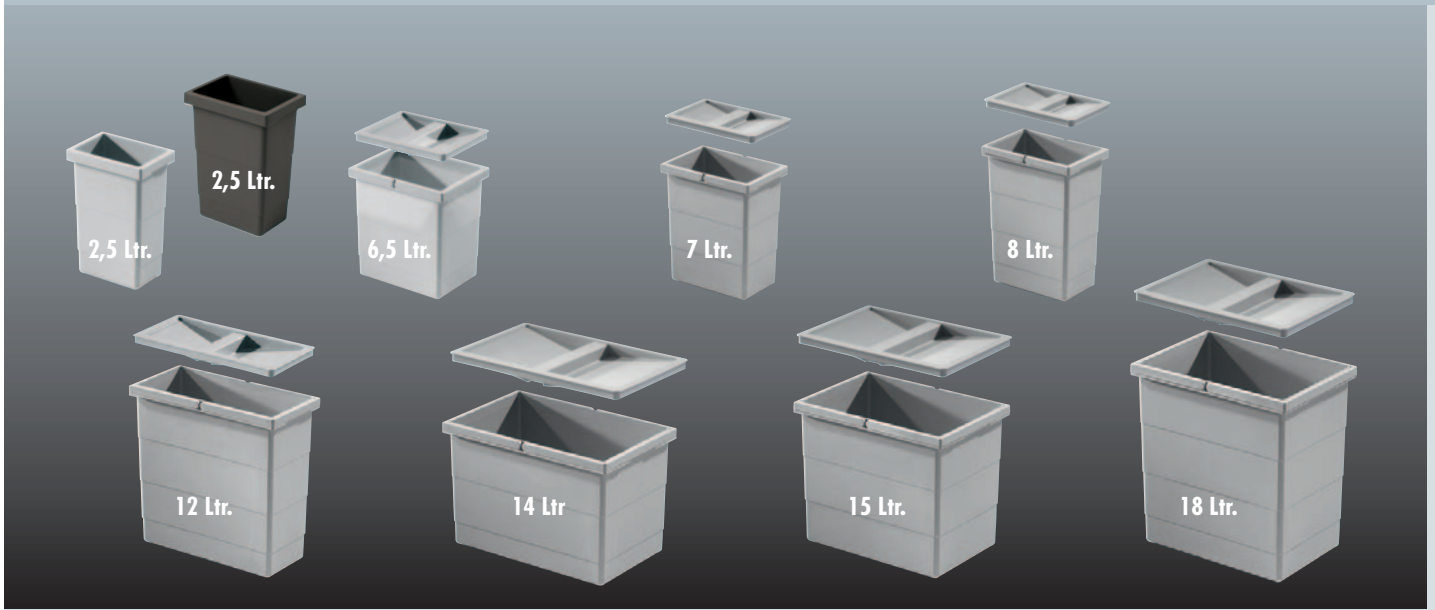

Hailo Inneneimer

Hailo Inner Bins



Art. Nr. Deckel/lid			1107279	1100719	1068589
Art. Nr. Eimer/bin	1102429	1129889	1107289	1073979	1102439
Volumen ca./ Volume aprox.	2,5 Liter	2,5 Liter	6,5 Liter	14 Liter	7 Liter
Breite/Tiefe / Width/Depth	B x T / W x D	B x T / W x D	B x T / W x D	B x T / W x D	B x T / W x D
Eimerhöhe/bin height 220 mm	155 x 110	155x 110	226 x 174	350 x 226	
Eimerhöhe/bin height 255 mm					226 x 156
Eimerhöhe/bin height 295 mm					
Müllbeutel/trashbag					

Müllbeutel

Trash-Bags

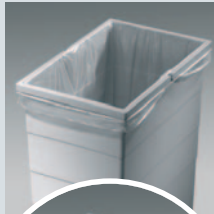

Wir bieten passgenaue Müllbeutel in 7 verschiedenen Größen für die jeweiligen Inneneimer an. Die Piktogramme für den jeweils passenden Müllbeutel sind in der Inneneimerübersicht sowie bei Produkten mit entsprechendem Inneneimer zu finden.

We offer custom-fit trash bags in 7 different sizes for the corresponding inner bins. The icon for the appropriate trash bag can be found in the inner bin list as well as with products with corresponding inner bin.



Art. Nr. 0010001



Art. Nr. 0020181



Art. Nr. 0040001



Art. Nr. 0013081



Art. Nr. 0018081



Art. Nr. 0028081



Art. Nr. 0055081



1104849

1102459

15 Liter

B x T / W x D

320 x 226



1068589

1075959

8 Liter

B x T / W x D

226 x 156



1107249

1102449

12 Liter

B x T / W x D

320 x 156



1104849

1093479

18 Liter

B x T / W x D

320 x 226



Hailo Inneneimer

Hailo Inner Bins

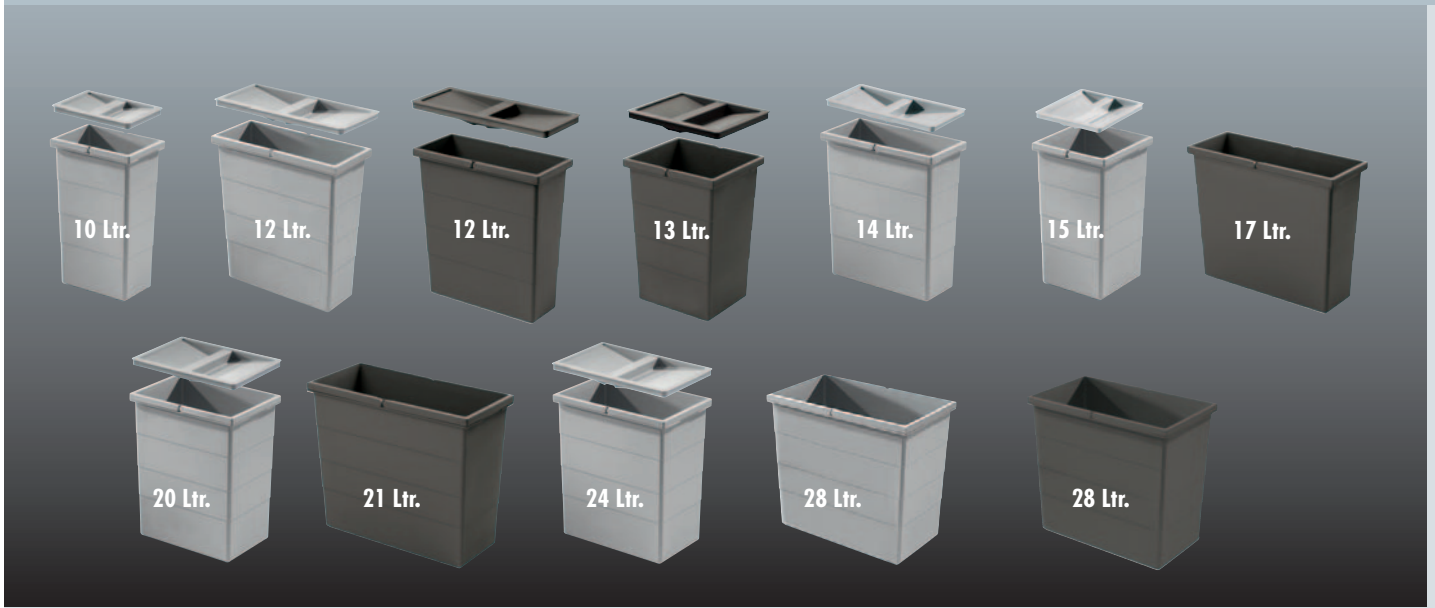

Hailo Inneneimer

Hailo Inner Bins



Art. Nr. Deckel/lid	1068589	1125089	1134679	1220069	1107249	
Art. Nr. Eimer/bin	1075969	1122459	1134669	1138999	1075989	
Volumen ca./ Volume aprox.	10 Liter	12 Liter	12 Liter	13 Liter	14 Liter	
Breite/Tiefe / Width/Depth	B x T / W x D	B x T / W x D	B x T / W x D	B x T / W x D	B x T / W x D	
Eimerhöhe/bin height 350 mm	226 x 156	320 x 141	320 x 141	207 x 242	320 x 156	
Müllbeutel/trashbag						

Müllbeutel

Trash-Bags

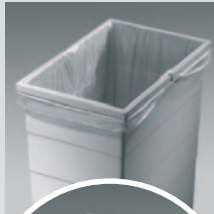

Wir bieten passgenaue Müllbeutel in 7 verschiedenen Größen für die jeweiligen Inneneimer an. Die Piktogramme für den jeweils passenden Müllbeutel sind in der Inneneimerübersicht sowie bei Produkten mit entsprechendem Inneneimer zu finden.

We offer custom-fit trash bags in 7 different sizes for the corresponding inner bins. The icon for the appropriate trash bag can be found in the inner bin list as well as with products with corresponding inner bin.



Art. Nr. 0010001



Art. Nr. 0020181



Art. Nr. 0040001



Art. Nr. 0013081



Art. Nr. 0018081



Art. Nr. 0028081



Art. Nr. 0055081



1107269

x

1104849

x

1100719

x

x

1076099

1139009

1076119

1129669

1076129

1125729

1129969

15 Liter

17 Liter

20 Liter

21 Liter

24 Liter

28 Liter

28 Liter

B x T / W x D

B x T / W x D

B x T / W x D

B x T / W x D

B x T / W x D

B x T / W x D

B x T / W x D

226 x 233

415 x 158

320 x 226

415 x 192

350 x 226

242 x 415

242 x 415



Hailo Inneneimer

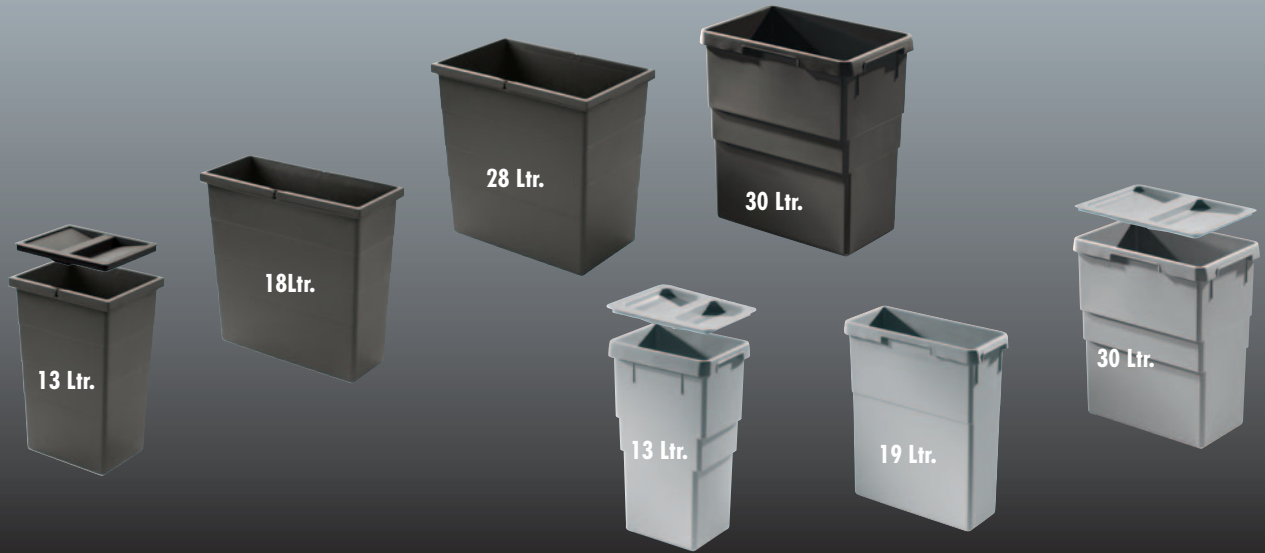

Hailo Inner Bins



Hailo Inneneimer

Hailo Inner Bins



Art. Nr. Deckel/lid	1220389	x	x	
Art. Nr. Eimer/bin	1220359	1220369	1220379	
Volumen ca./ Volume aprox.	13 Liter	18 Liter	28 Liter	
Breite/Tiefe / Width/Depth	B x T / W x D	B x T / W x D	B x T / W x D	
Eimerhöhe/bin height 380 mm	242 x 192	385 x 166	385 x 242	
Eimerhöhe/bin height 413 mm				
Müllbeutel/trashbag				

Müllbeutel

Trash-Bags



Wir bieten passgenaue Müllbeutel in 7 verschiedenen Größen für die jeweiligen Inneneimer an. Die Piktogramme für den jeweils passenden Müllbeutel sind in der Inneneimerübersicht sowie bei Produkten mit entsprechendem Inneneimer zu finden.

We offer custom-fit trash bags in 7 different sizes for the corresponding inner bins. The icon for the appropriate trash bag can be found in the inner bin list as well as with products with corresponding inner bin.



Art. Nr. 0010001



Art. Nr. 0020181



Art. Nr. 0040001



Art. Nr. 0013081



Art. Nr. 0018081



Art. Nr. 0028081



Art. Nr. 0055081



1107239

x

1069559

x

1107229

1071319

1058089

1137679

13 Liter

19 Liter

30 Liter

30 Liter

B x T / W x D

B x T / W x D

B x T / W x D

B x T / W x D

258 x 198

397 x 171

397 x 258

397 x 258



Hailo Inneneimer



Hailo Inner Bins



Hailo Inneneimer

Hailo Inner Bins



Art. Nr. Deckel/lid	1100719	x	x	
Art. Nr. Eimer/bin	1100709	1080369	1139029	
Volumen ca./ Volume aprox.	29 Liter	42 Liter	55 Liter	
Breite/Tiefe / Width/Depth	B x T / W x D	B x T / W x D	B x T / W x D	
Eimerhöhe/bin height 485 mm	350 x 226			
Eimerhöhe/bin height 500 mm		415 x 285	385 x 358	
Eimerhöhe/bin height 522 mm				
Eimerhöhe/bin height 525 mm				
Müllbeutel/trashbag				

Müllbeutel



Wir bieten passgenaue Müllbeutel in 7 verschiedenen Größen für die jeweiligen Inneneimer an. Die Piktogramme für den jeweils passenden Müllbeutel sind in der Inneneimerübersicht sowie bei Produkten mit entsprechendem Inneneimer zu finden.



Art. Nr. 0010001



Art. Nr. 0020181



Art. Nr. 0040001



Art. Nr. 0013081



Art. Nr. 0018081



Art. Nr. 0028081



Art. Nr. 0055081

Trash-Bags

We offer custom-fit trash bags in 7 different sizes for the corresponding inner bins. The icon for the appropriate trash bag can be found in the inner bin list as well as with products with corresponding inner bin.



1128339

x

1100719

1014169

1132999

1130439

38 Liter

38 Liter

32 Liter

B x T / W x D

B x T / W x D





















B x T / W x D

378 x 261

378x 261

350 x 226



Breite/Width	155 mm	207 mm	226 mm	226 mm	233 mm	242 mm	258 mm	320 mm	320 mm	320 mm	350 mm
Tiefe/Depth	110 mm	242 mm	156 mm	174 mm	226 mm	192 mm	198 mm	141 mm	156 mm	226 mm	226 mm
	Art. Nr.	Art. Nr.	Art. Nr.	Art. Nr.	Art. Nr.	Art. Nr.	Art. Nr.	Art. Nr.	Art. Nr.	Art. Nr.	Art. Nr.
Eimerhöhe bin height 220 mm	1129889  2,5l 1102429			1107279  6,5l 1107289							1100719  14l 1073979
255 mm			1068589  7l 1102439							1104849  15l 1102459	
295 mm			1068589  8l 1075959					1107249  12l 1102449	1104849  18l 1093479		
350 mm		1220069  13l 1138999	1068589  10l 1075969		1107269  15l 1076099			1125089  12l 1122459 1134679 1134669  12l	1107249  14l 1075989	1104849  20l 1076119	1100719  24l 1076129
380 mm						1220389  13l 1220359					
413 mm							1107239  13l 1107229				
485 mm											1100719  29l 1100709
500 mm											
522 mm											
525 mm											1100719  32l 1130439

* ohne Bügel / without handles ** ohne Bügel, mit integrierten geformten Griffen / without handles, with integrated moulded grip

Hailo Inneneimer





Hailo Inner Bins

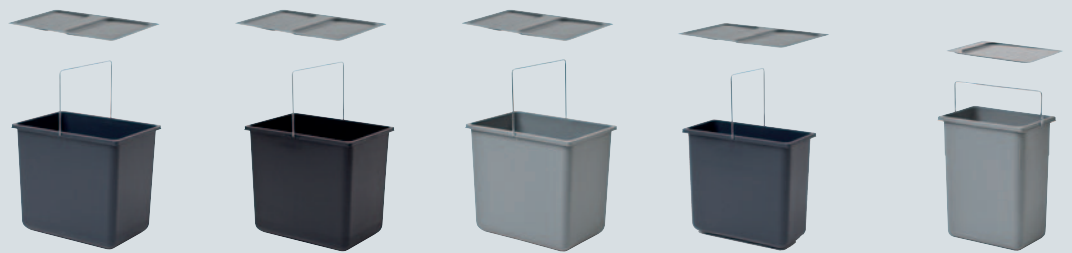

Hailo Inneneimer

Hailo Inner Bins



Art. Nr. Deckel/lid	1017519	1017519	1017519	1069619	1082739
Art. Nr. Eimer/bin	1049519	1086239	1094079	1049479	1094089
Volumen ca./ Volume aprox.	18 Liter	18 Liter	18 Liter	12 Liter	8,5 Liter
Breite/Tiefe / Width/Depth	B x T / W x D	B x T / W x D	B x T / W x D	B x T / W x D	B x T / W x D
Eimerhöhe/bin height 295 mm	316 x 226	316 x 226	316 x 226	316 x 154	226 x 150
Eimerhöhe/bin height 325 mm					
Eimerhöhe/bin height 350 mm					
Müllbeutel/trashbag					

Müllbeutel

Trash-Bags

Wir bieten passgenaue Müllbeutel in 3 verschiedenen Größen für die jeweiligen Inneneimer an.
Die Größen S, M und L sind in der Inneneimerübersicht sowie bei Produkten mit entsprechendem Inneneimer zu finden.

We offer custom-fit trash bags in 3 different sizes for the corresponding inner bins.
The sizes S, M and L can be found in the inner bin list as well as with products with corresponding inner bin.



Art. Nr. 0010001



Art. Nr. 0020181



Art. Nr. 0040001



1082739

1049529

8,5 Liter

B x T / W x D

226 x 150



1082489

20 Liter

B x T / W x D

310 x 225



1082609

20 Liter

B x T / W x D

310 x 225



1082599

20 Liter

B x T / W x D

310 x 225



1082739

1045639

10 Liter

B x T / W x D

226 x 154



1082739

1045629

10 Liter

B x T / W x D

226 x 154



Hailo Inneneimer







Hailo Inner Bins



Hailo Inneneimer

Hailo Inner Bins



Art. Nr. Deckel/lid						
Art. Nr. Eimer/bin	1082479	1082419	1080989	1068909	1220179	1080999
Volumen ca./ Volume aprox.	7 Liter	7 Liter	7 Liter	7 Liter	7 Liter	7 Liter
Breite/Tiefe / Width/Depth	B x T / W x D	B x T / W x D	B x T / W x D	B x T / W x D	B x T / W x D	B x T / W x D
Eimerhöhe/bin height 350 mm	226 x 115	226 x 115	226 x 115	226 x 115	226 x 115	226 x 115
Müllbeutel/trashbag						

Müllbeutel

Trash-Bags

Wir bieten passgenaue Müllbeutel in 3 verschiedenen Größen für die jeweiligen Inneneimer an.
Die Größen S, M und L sind in der Inneneimerübersicht sowie bei Produkten mit entsprechendem Inneneimer zu finden.

We offer custom-fit trash bags in 3 different sizes for the corresponding inner bins.
The sizes S, M and L can be found in the inner bin list as well as with products with corresponding inner bin.



Art. Nr. 0010001



Art. Nr. 0020181



Art. Nr. 0040001



1138919	1077859	1050209	1045129	1008879	1220189
20 Liter	20 Liter	24 Liter	24 Liter	15 Liter	15 Liter
B x T / W x D	B x T / W x D	B x T / W x D	B x T / W x D	B x T / W x D	B x T / W x D
316 x 226	316 x 226	345 x 220	345 x 220	230 x 220	230 x 220

Hailo Inneneimer

Hailo Inner Bins



Hailo Inneneimer

Hailo Inner Bins



Art. Nr. Eimer/bin	1045119	1073259	1073269	1082119	1082399
Volumen ca./ Volume aprox.	15 Liter	15 Liter	15 Liter	18 Liter	8 Liter
Breite/Tiefe / Width/Depth	B x T / W x D	B x T / W x D	B x T / W x D	B x T / W x D	B x T / W x D
Eimerhöhe/bin height 350 mm	230 x 220	230 x 220	230 x 220		
Eimerhöhe/bin height 365 mm				343 x 185	
Eimerhöhe/bin height 367 mm					187 x 171
Eimer/bin Ø 270 mm					
Eimer/bin Ø 275 mm					
Müllbeutel/trashbag					

Müllbeutel

Trash-Bags

Wir bieten passgenaue Müllbeutel in 3 verschiedenen Größen für die jeweiligen Inneneimer an.
Die Größen S, M und L sind in der Inneneimerübersicht sowie bei Produkten mit entsprechendem Inneneimer zu finden.

We offer custom-fit trash bags in 3 different sizes for the corresponding inner bins.
The sizes S, M and L can be found in the inner bin list as well as with products with corresponding inner bin.



Art. Nr. 0010001



Art. Nr. 0020181



Art. Nr. 0040001



1082409

8 Liter

1081529

12 Liter

1081699

15 Liter

1138739

15 Liter

1082629

15 Liter

1030459

20 Liter

B x T / W x D

∅

∅

∅

∅

∅

187 x 171

270

270

270

275

275















Hailo Inneneimer

Hailo Inner Bins

Breite/Width	187 mm	226 mm	226 mm	226 mm	230 mm
Tiefe/Depth	171 mm	115 mm	150 mm	154 mm	220 mm
	Art. Nr.	Art. Nr.	Art. Nr.	Art. Nr.	Art. Nr.
Eimerhöhe bin height 253 mm					
295 mm			 <p>1082739</p> <p>1094089 hellgrau/light-grey 1049529 dunkelgrau/dark-grey</p>		
299 mm					
324 mm					
325 mm					
350 mm		 <p>1082479 grau/grey 1082419 weiß/white 1080989 grün/green 1080999 braun/brown 1068909 hellgrau/light grey 1220179 dunkelgrau/dark-grey</p>	 <p>1045639 grau/grey 1045629 weiß/white</p>	 <p>1008879 grau/grey 1045119 weiß/white 1073259 grün/green 1073269 braun/brown 1220189 dunkelgrau/dark-grey</p>	
365 mm					
367 mm	 <p>1082399 1082409</p>				
413 mm					

310 mm	316 mm	316 mm	342 mm	345 mm	∅	∅
225 mm	154 mm	226 mm	181 mm	220 mm	270 mm	275 mm
Art. Nr.	Art. Nr.	Art. Nr.	Art. Nr.	Art. Nr.	Art. Nr.	Art. Nr.
					 12l 1081529	
	 12l 1069619 1049479	 18l 1017519 1094079 hellgrau/light-grey 1049519 dunkelgrau/dark-grey 1086239 schwarz/black				
						 15l 1082629
					 15l 1138739 1081699	
 20l 1082609 grau/grey 1082489 weiß/white 1082599 braun/brown						
		 20l 1138919	 20l 1077859	 24l 1050209 grau/grey 1045129 weiß/white		
			 18l 1082119			
						 20l 1030459



Übrigens, wussten Sie, ...

dass die Marke Hailo in Deutschland einen Bekanntheitsgrad von etwa 68 % besitzt?

By the way, did you know...

that the Hailo brand enjoys a recognition factor of approx. 68 % in Germany?



Zubehör-, Ordnungs- und Funktionseinsätze für Auszugssysteme von Hailo Accessories, Organizer- & Functional-Inserts for Hailo recycling-systems.

Hailo On Top Behälter

3205101



- Behälter: 1 x 4 l, hellgrün/weiß
1 x Behälterdeckel 4 l
- Produkt-Maße
B x T x H, 230 x 180 x 107 mm
- Verpackungsmaße: B x T x H, 247 x 190 x 121 mm
- Gewicht mit Verpackung 0,7 kg

Schlauchbrausenabweiser

3693001

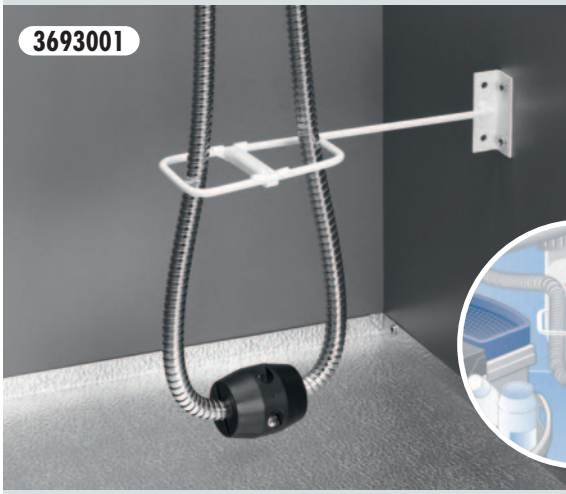

Metallbügel zum Einbau in Spülenunterschranke zur gezielten Schlauchführung.

- Verpackungseinheit: 5
- Gewicht mit Verpackung 0,2 kg

Hailo On Top Container

- Container: 1 x 4 l, light green/white, 1 x Lid 4 l
- Product Dimensions:
W x D x H, 230 x 180 x 107 mm
- Packing dimensions: W x D x H, 247 x 190 x 121 mm
- Weight incl. packing 0,7 kg

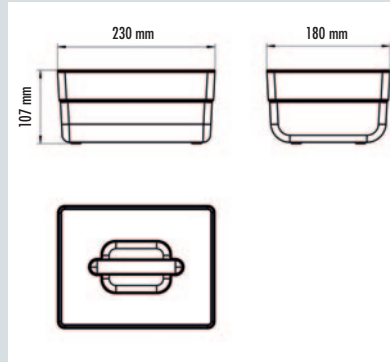

Wall-Bracket for Flex-Hose

Wire bracket for sink-cabinets,
for rerouting of flexible hoses.

- **Packing unit: 5 each per carton**
- Weight incl. packing 0,2 kg



Zubehör-, Ordnungs- und Funktionseinsätze für Auszugssysteme von Hailo Accessories, Organizer- & Functional-Inserts for Hailo recycling-systems.

Hailo Kitty

3204101



- Inhalt: 4 l
- Kunststoffbehälter: dunkelgrau
- Deckel+Griff: hellgrau
- Produktmaße: B x T x H, 250x160x170 mm
- Verpackungsmaße: B x T x H, 265 x 175 x 180 mm
- Gewicht: 0,86 kg

Hailo Kitty

3204901



- Inhalt: 4 l
- Kunststoffbehälter: weiß
- Deckel+Griff: weiß
- Produktmaße: B x T x H, 250x160x170 mm
- Verpackungsmaße: B x T x H, 265 x 175 x 180 mm
- Gewicht: 0,86 kg

- Capacity: 4 l
- Plastic Body: dark-grey
- Lid+Handle: light-grey
- Product-dimensions: : W x D x H, 250 x 160 x 170 mm
- Packing dimensions: W x D x H, 265 x 175 x 180 mm
- Weight: 0,86 kg



- Capacity: 4 l
- Plastic Body: white
- Lid+Handle: white
- Product-dimensions: : W x D x H, 250 x 160 x 170 mm
- Packing dimensions: W x D x H, 265 x 175 x 180 mm
- Weight: 0,86 kg



Mehr von Hailo Einbautechnik.

More from Hailo Built-In Technology.

Kundenspezifische Lösungen

Customized Solutions

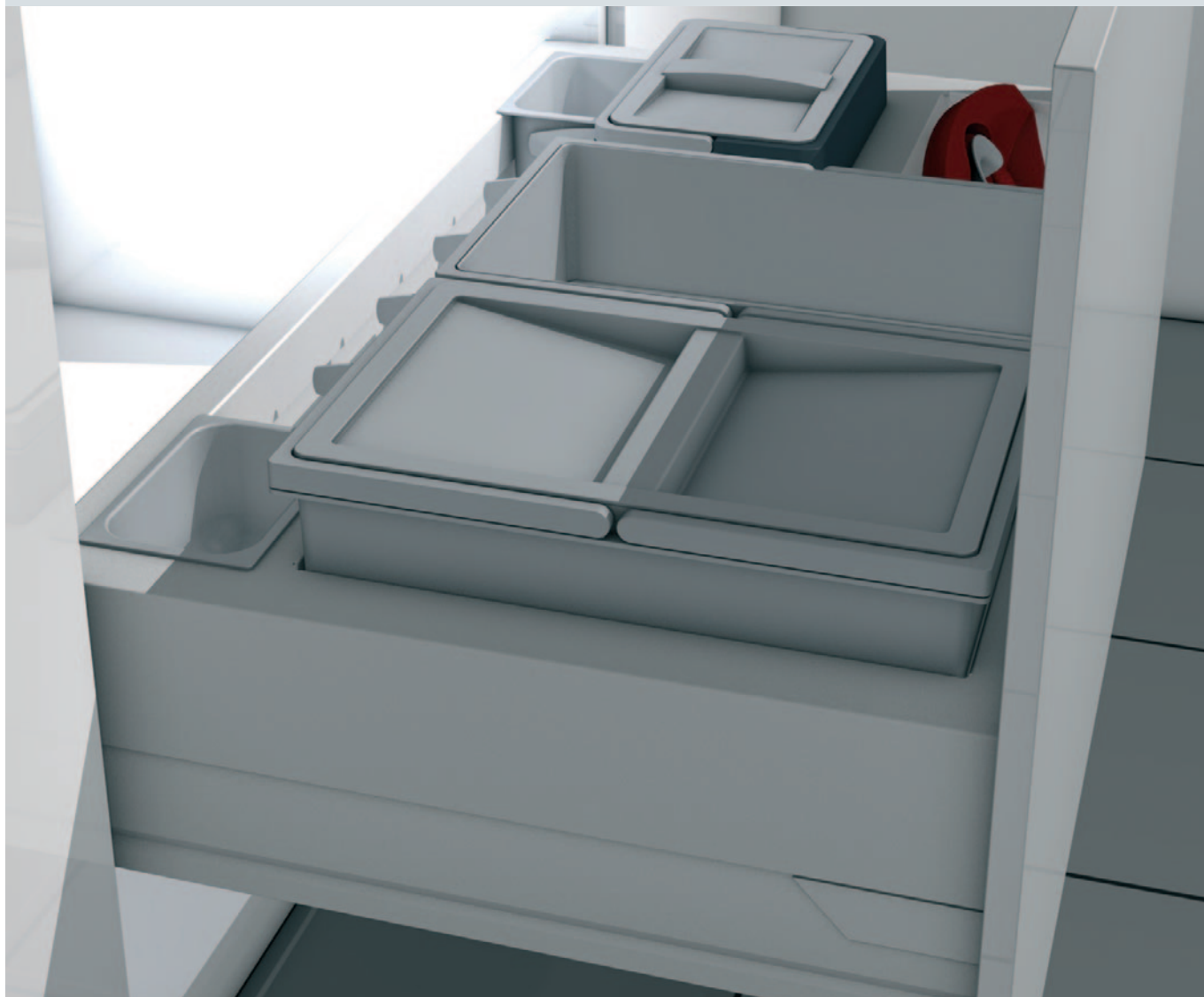

Neben dem umfangreichen Sortiment an Abfalltrenn- und Ordnungssystemen aus dem Standard Programm, bietet Hailo maßgeschneiderte, kundenspezifische Lösungen, die ihre Küchenmarke darin unterstützen einmalige Attribute aufzuweisen. Passgenaue Entwicklungen auf alle vorhandenen Auszüge und Schubkastensysteme namhafter Hersteller wie Blum, Grass, Hettich und weitere bieten Individualität und ein hohes Maß an Differenzierung.

Diesen Mehrwert in der Raumausnutzung und Gestaltung der Auszüge und Schubkästen entwickelt Hailo gemeinsam mit Ihnen und für Sie. Als Marktführer im Bereich Einbauten in Küchenschränke und Schubkästen finden wir auch für Sie passende Möglichkeiten. Viele namhafte Küchenhersteller vermarkten bereits erfolgreich ihre Küchen mit maßgefertigten Einbau-Systemen von Hailo.

As well as the extensive choice of waste separation and storage systems in its standard range, Hailo offers made-to-measure, customised solutions that support kitchen brands with their unique features. Precision-fit developments for all existing drawer systems and storage units supplied by well-known manufacturers, such as Blum, Grass, Hettich and others, lend individuality and provide for a high degree of differentiation.

Hailo develops this added value in the utilisation of space and the design of the drawer systems and storage units with you and for you. As the market leader in the kitchen cupboard and drawer storage fittings sector, we'll find the right options for you, too. Many well-known kitchen manufacturers already successfully market their kitchens with customized recycling systems.

Kundenspezifische Lösungen für Zargen (hängende Systeme) Customized solutions for Drawers (hang-thru bin systems)



Zargen Cargo



Passend auf alle handelsüblichen Zargen entwickelt Hailo ein patentiertes Abfalltrennsystem, das gleich mehrere Vorteile aufweist:

- Einfache Montage
- Unveränderte Frontanbindung
- Stabilität
- Hygiene
- Individualität
- Vielseitigkeit

Konfigurieren Sie sich die Einsätze für ihr System selbst. Wählen Sie ihre individuelle Systembestückung aus einer Vielzahl von Eimern und Einsätzen (siehe Seiten 215-222).

Beispiel einer Kundenlösung auf 60er Zarge

Drawer Cargo

Suitable for all standard drawer frames, Hailo can develop a patented waste separation system for you that provides several benefits:

- Easy Installation
- Front-Attachment and -Adjustment as usual
- Stability
- Hygiene
- Individuality
- Variability

Configuration of Bins and Inserts as per your requirement, and available space. (Pages 215-222)

Example of a customized solution on a 60-drawer frame

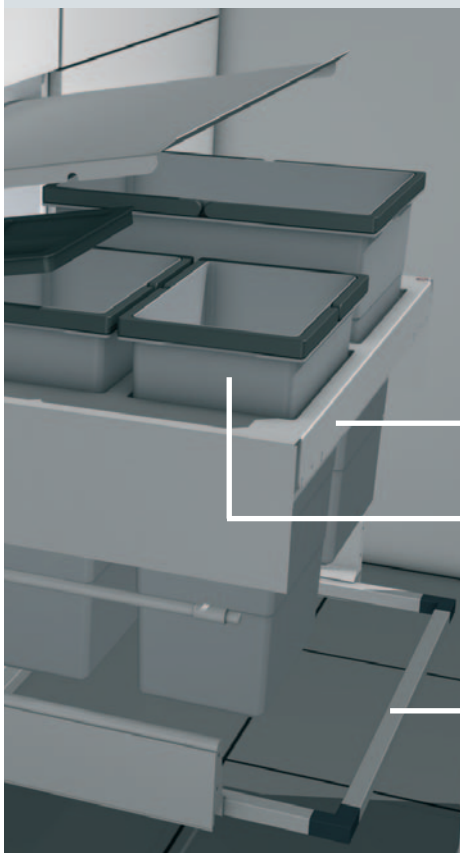

- **Tragendes System.**
Behälter hängen frei in der Eimeraufnahme. Schubkastenboden nicht nötig.
- **Individuelle Eimerbestückung.**
Große Vielfalt an Varianten und Eimerkombinationen wählbar.
- **Geschlossenes System.**
Glatte, reinigungsfreundliche Flächen. Fehleinwurf wird vermieden.
- **Stabilisierungsrahmen**
als Ersatz für den Schubkastenboden. Zarge sitzt höher als bei normalem Auszug - dadurch erhöhte Stabilität.
- **Einstellbarkeit des Auszugs**
Herkömmliche Einstellbarkeit der Front bleibt erhalten. Es werden keine weiteren Befestigungswinkel benötigt.
- **Passende Systeme für alle Zargen.**
Egal welcher Hersteller, egal welche Breite oder Tiefe.
- **Einfache Montage,**
bewährte Frontanbindung.

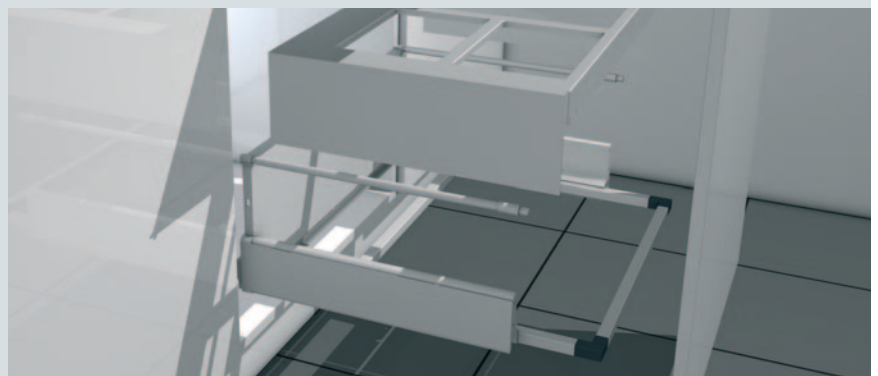

- **Upper Bins Frame, hang - thru bins,**
without drawer bottom.
- **Individual bin configuration,**
as per cabinet-maker's requirements.
- **Closed system, flush sides & surfaces.**
- **Stabilizer frame, Alu,**
replaces drawer-bottom.
- **Adjustment of front-panel**
and attachment in the usual way.
Not any extra brackets needed.
- **Suitable systems for all common**
drawers, of any make, of any width,
or depth.
- **Easy installation,**
usual front-adjustment.

Kundenspezifische Lösungen für Schubkästen (stehende Systeme) Customized solutions for common drawers (standing bins systems)

Hailo Separato

Hailo Separato

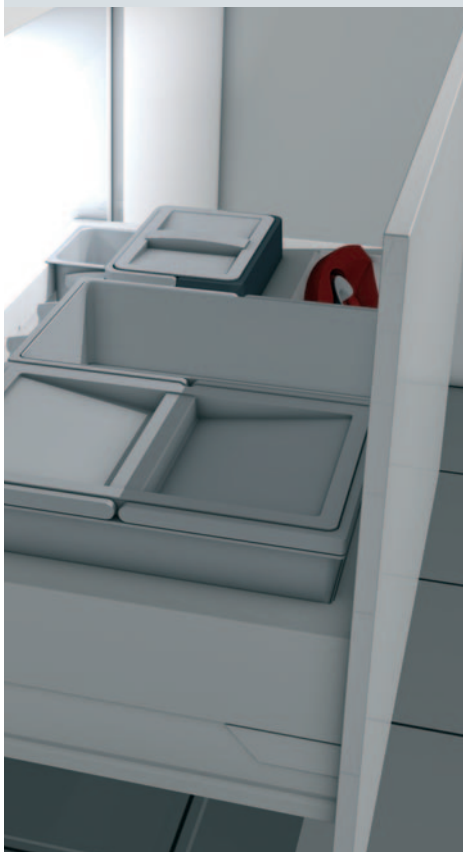

Für alle Schubladen und Schubkästen ab 2-Raster Höhe bietet Hailo mit dem Separato-System individuelle Gestaltungsmöglichkeiten.

Neu entwickeltes Hailo-System, patentiert, das gleich mehrere Vorteile aufweist:

- Einfache Montage
- Unveränderte Frontanbindung
- Stabilität
- Hygiene
- Individualität
- Vielseitigkeit
- Optimierter Installationsraum

For all drawers from 2 levels height, Hailo offers individual designs & solutions. Newly developed Hailo-system, patented, with various advantages:

- Easy Installation
- Usual Front - Adjustment and Attachment
- Stability
- Hygiene
- Individuality
- Flexibility
- Optimized Installation Area

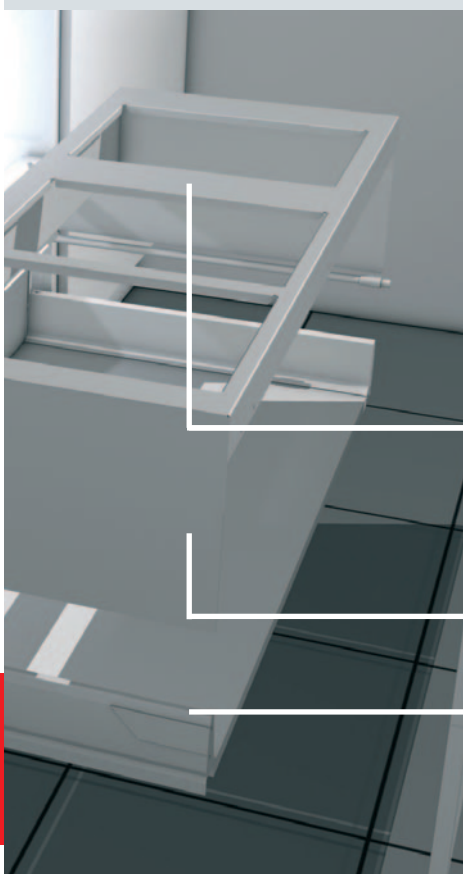
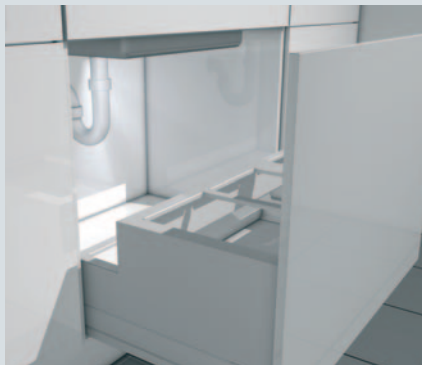

- **Individuelle Bestückung**
Eimer mit Ordnungs- und Reinigungssystemen. Abfallbehälter, Universalbehälter, Kehrsetz uvm.
- **Optimale Stauraumnutzung**
Abfalltrennung, Ordnungsmittel übersichtlich, griffbereit zur Hand.
- **Geschlossenes System der Eimeraufnahme**
Fehleinwurf wird verhindert. Glatte Reinigungsflächen.
- **Einstellbarkeit des Auszugs**
Herkömmliche Einstellbarkeit der Front bleibt erhalten. Es werden keine weiteren Befestigungswinkel benötigt.
- **Einfache Montage,**
bewährte Frontanbindung.

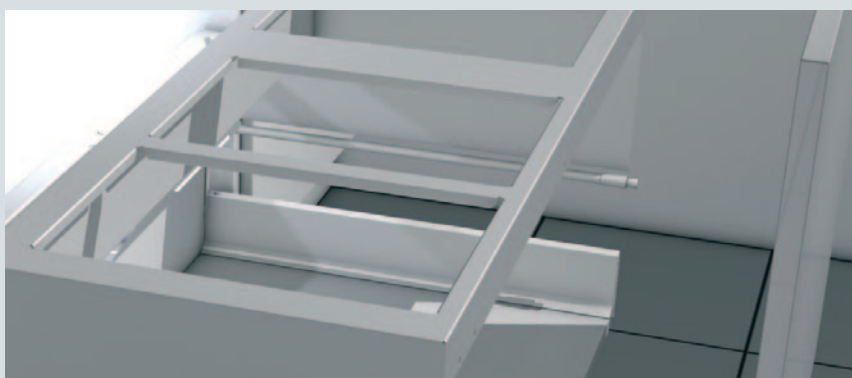

- **Individual Configuration**
Bins, organizer, and cleansers-inserts.
- **Optimized utilisation of space.**
Recycling- and Organizer-Center
- **Closed upper frame flush surfaces.**
No miss-hits. No mess. Smooth surfaces for cleaning.
- **Usual Attachment and Adjustment of front-panel.**
No any further brackets required.
- **Easy Installation** - usual front attachment

Speziellösungen für den Großraum-Sockelauszug Special solutions for high-capacity Plinth Drawers



Hailo Sockel Cargo

Plinth Drawer Cargo

Optimale Raumausnutzung und ideale Ausgestaltung des Sockelschubkastens. Inkl. Nutzung des Sockelraumes.

- **Optimale Stauraumnutzung** inkl. Nutzung des Sockelraumes.
- **Geschlossenes System der Eimeraufnahme**
Fehleinwurf wird verhindert. Glatte Reinigungsflächen.
- **Einstellbarkeit des Auszugs** wird durch das System nicht beeinträchtigt.
- **Einfache Montage,** bewährte Frontanbindung.



Optimized utilisation of available space, and ideal use of plinth-drawer, including use of plinth-area.

- **Makes the best use of storage space**
Also utilises space behind plinth for storage.
- **Closed bins frame, flush surfaces,** easy to clean. No miss-hits. No mess. Smooth surfaces for cleaning.
- **Adjustment of pull-out** is still be maintained.
- **Easy Installation,** usual front-attachment



Platz für Ihre Notizen:

Space for your notes:

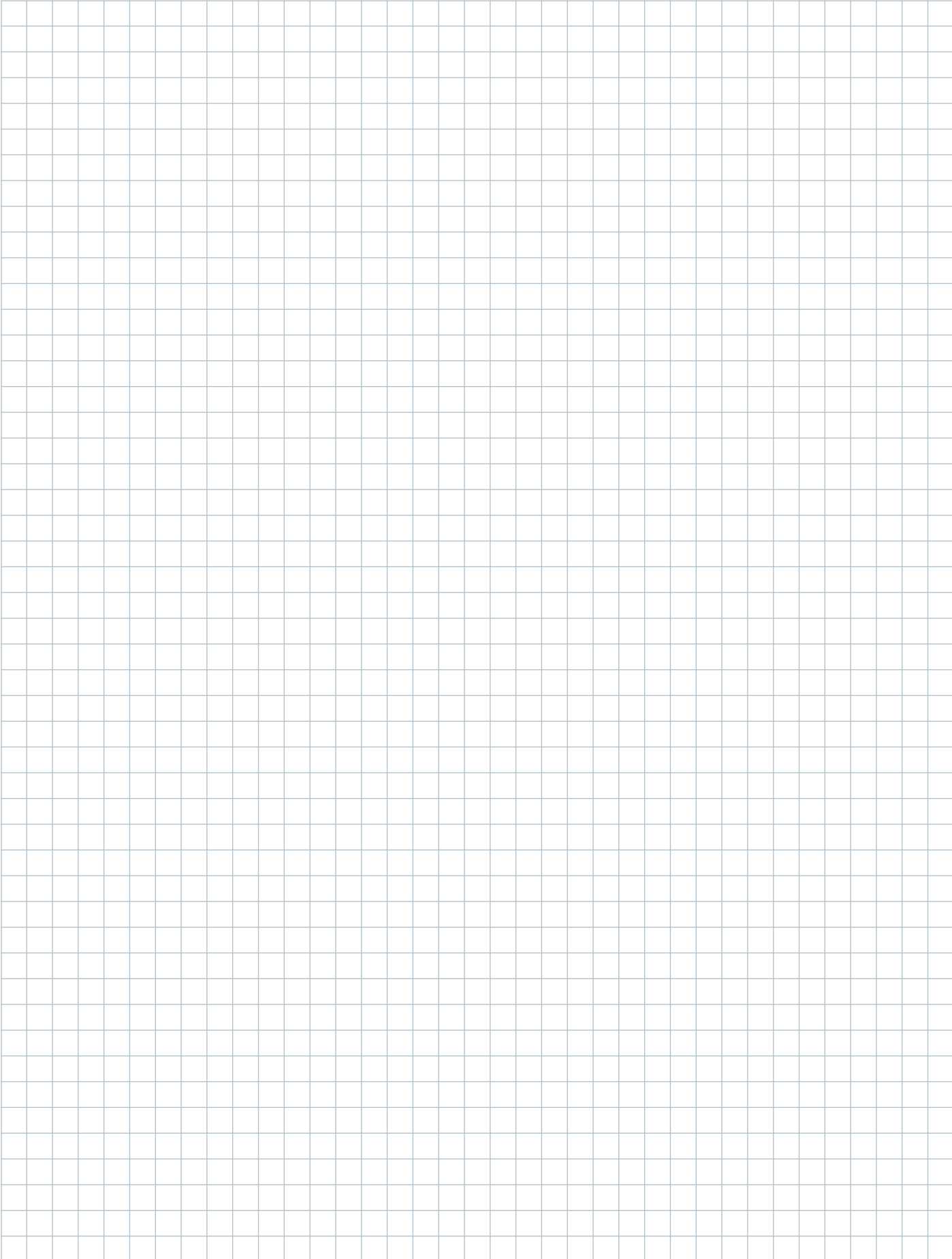

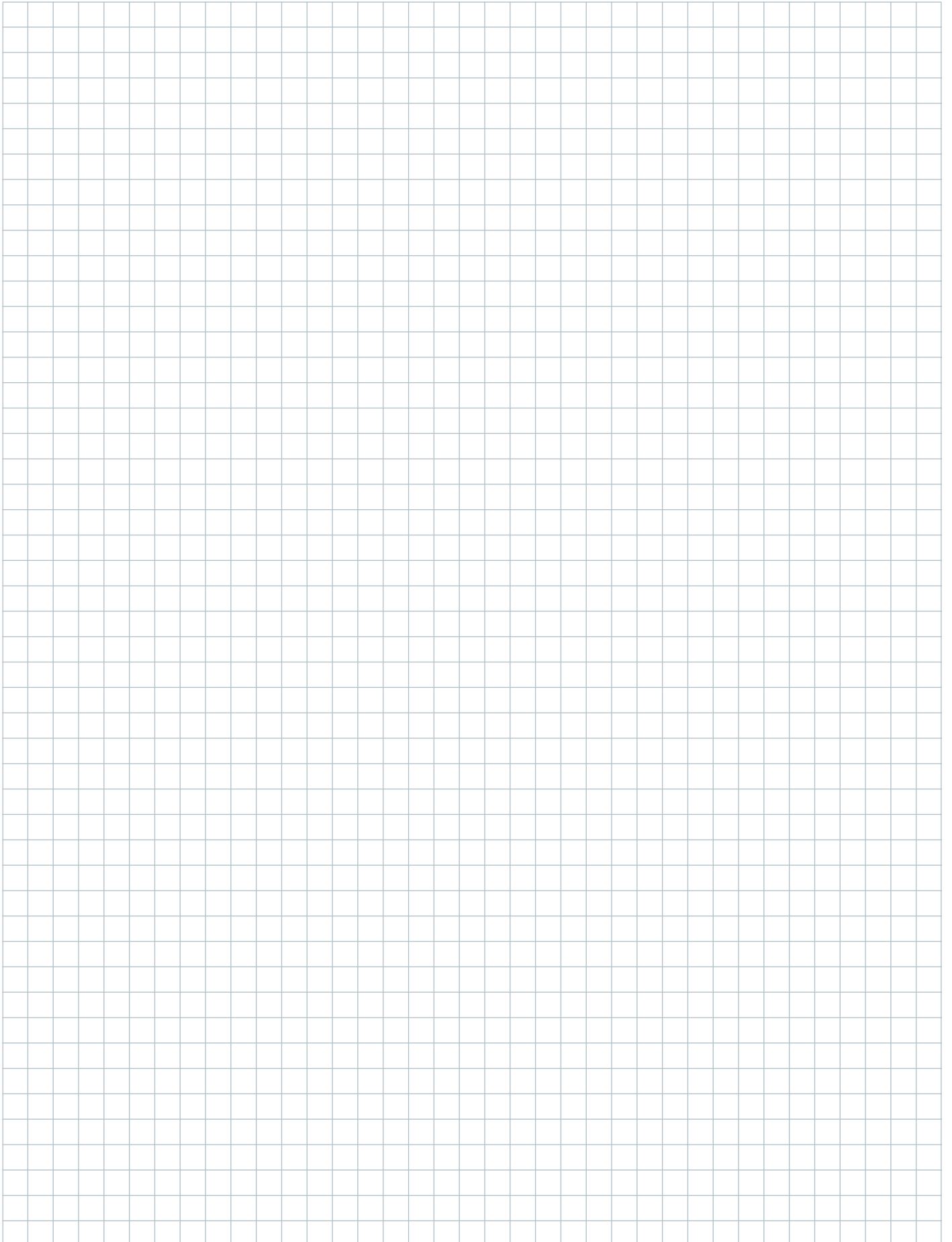

Platz für Ihre Notizen:

Space for your notes:

